



# User Manual

for S6 Series Hybrid Inverter



Applicable models

S6-EH1P9.9K03-NV-YD-L

S6-EH1P10K03-NV-YD-L

S6-EH1P12K03-NV-YD-L

S6-EH1P14K03-NV-YD-L

S6-EH1P16K03-NV-YD-L

Applicable System

Single phase system

# Important Notes

---

- Due to the product development, the product specifications and functions are subject to change. The latest manual can be acquired via <https://www.ginlong.com/global>. Every attempt has been made to make this document complete, accurate and up-to-date. Individuals reviewing this document and installers or service personnel are cautioned, however, that Solis reserves the right to make changes without notice and shall not be responsible for any damages, including indirect, incidental or consequential damages caused by reliance on the material presented including, but not limited to, omissions, typographical errors, arithmetical errors or listing errors in the material provided in this document.
- Solis accepts no liability for customers' failure to comply with the instructions for correct installation and will not be held responsible for upstream or downstream systems Solis equipment has supplied.
- The customer is fully liable for any modifications made to the system; therefore, any hardware or software modification, manipulation, or alteration not expressly approved by the manufacturer shall result in the immediate cancellation of the warranty.
- Given the countless possible system configurations and installation environments, it is essential to verify adherence to the following:
  - There is sufficient space suitable for housing the equipment.
  - Airborne noise produced depending on the environment.
  - Potential flammability hazards.
  - Solis will not be held liable for defects or malfunctions arising from:
    - Improper use of the equipment.
    - Deterioration resulting from transportation or particular environmental conditions.
    - Performing maintenance incorrectly or not at all.
    - Tampering or unsafe repairs.
    - Use or installation by unqualified persons.
    - This product contains lethal voltages and should be installed by qualified electrical or service personnel having experience with lethal voltages.

<b>1. Introduction</b>	<b>01-04</b>
1.1 Product Overview	01
1.2 Inverter Wire Box and Connection Points	02
1.3 Product Features	03
1.4 Packaging	04
1.5 Tools Required for Installation	04
<b>2. Safety &amp; Warning</b>	<b>05-07</b>
2.1 Safety	05
2.2 General Safety Instructions	05
2.3 Notice for Use	07
2.4 Notice for Disposal	07
<b>3. Installation</b>	<b>08-32</b>
3.1 Select a Location to Install the Inverter	08
3.2 Product Handling	10
3.3 Mounting the Inverter	11
3.4 Inverter Wiring Overview	13
3.5 Ground Cable Installation	14
3.6 PV Cable Installation	15
3.7 Battery Cable Installation	18
3.8 AC Wiring	19
3.9 CT Connection	20
3.10 Inverter Communication	21
3.11 Inverter Remote Monitoring Connection	29
3.12 Wiring Diagram Overview	30
3.13 Parallel system Wiring	31
<b>4. Overview</b>	<b>32-33</b>
4.1 Screen	32
4.2 LED Indicators	32
4.3 Keypad	33
4.4 Inverter built-in Bluetooth description	33
<b>5. Commissioning</b>	<b>34-36</b>
5.1 Pre-Commissioning	34
5.2 Power ON	34
5.3 Power OFF	34
5.4 HMI Screen Setting	35
5.5 APP Setting	36
<b>6. Maintenance</b>	<b>50</b>
6.1 Smart O&M	50
<b>7. Troubleshooting</b>	<b>51</b>
<b>8. Specifications</b>	<b>56</b>
<b>9. Appendix - FAQs</b>	<b>71</b>

## 1.1 Product Overview

The Solis S6 series is designed for residential hybrid systems.

The inverter can work with low-voltage lithium ion and Lead-acid batteries to maximize self-consumption and provide backup power if the grid fails and there is not enough PV power to cover load demand.

The Solis S6 series consists of the following inverter models:

9.9kW, 10kW, 12kW, 14kW, 16kW

The inverter supports the following power grid types: TN-S, TN-C, TN-C-S, and TT.

The inverter contains an internal NEB that meets the requirements of NRS 097-2-1: 2024 Section 5.4.

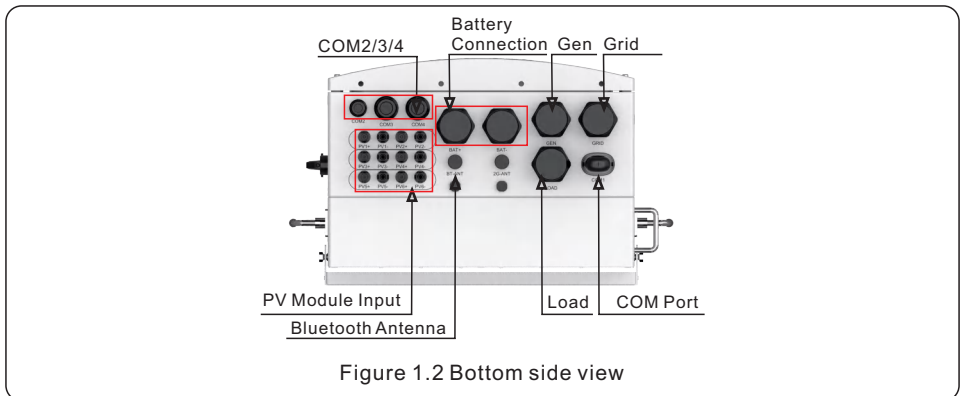
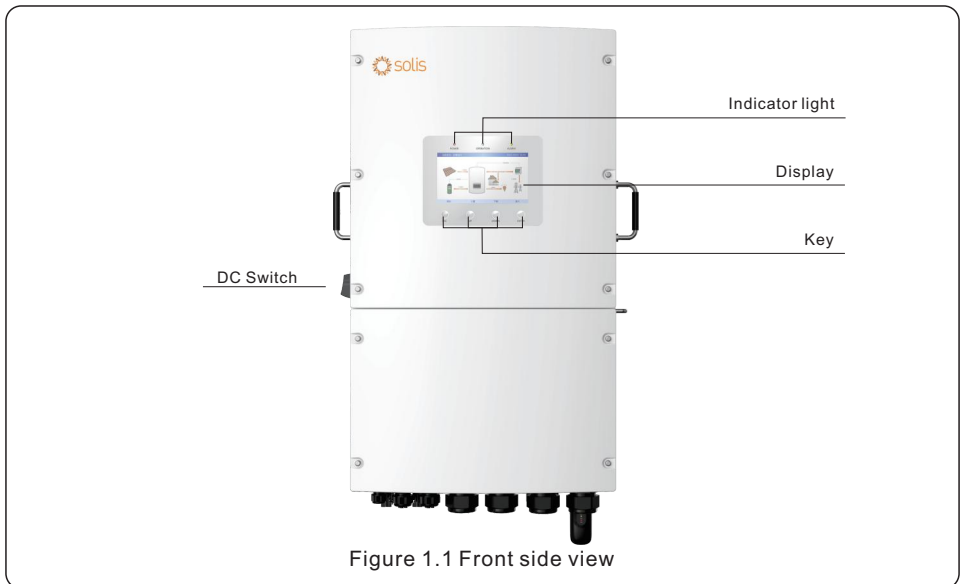

## 1.2 Inverter Wire Box and Connection Points

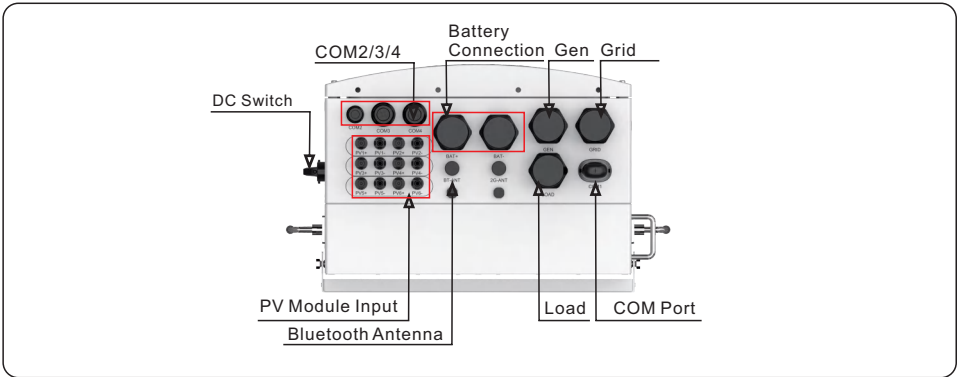

Name	Description
1. DC Switch	This is the DC disconnect switch for the PV
2. COM2	Conduit for CT conductors should be connected here
3. COM3	RS485 and CAN communication cables and parallel cables should go through these
4. COM4	RS485 and CAN communication cables and parallel cables should go through these
5. Battery Connection	Conduit for Battery conductors should be connected here
6. Gen	Conduit for AC conductors to generator should be connected here
7. Grid	Conduit for AC conductors to the main service panel should be connected here
8. PV Module Input	Conduit for PV conductors should be connected here
9. Bluetooth Antenna	Extends the range of the inverter Bluetooth signal(for system commissioning)
10. Load	Conduit for AC conductors to backup loads panel should be connected here
11. COM Port	Solis data logger gets connected here-only USB version of the loggers will work

## 1.3 Product Features

### Highly Flexible

- Integrated 3 MPPTs with 6 strings, suitable for residential rooftop installations with multiple array orientations.
- Compatible with multiple brands of battery models giving customers multiple battery options.
- 7-Inch colorful LCD screen and built in Bluetooth provide local operation without Internet.

### Outstanding Performance

- Up to 20A input current per string to support 182/210mm solar panels.
- Supports 1.6 DC:AC ratio to connect more PV capacity to the energy storage system.
- Up to 290A max.charge/discharge rating with industry highest level 16kW of backup loads support capability.
- UPS level switching time(<4ms)supporting critical loads all the time.
- High PV charge efficiency to prevent excess PV loss.
- 10 seconds 200% surge power backup overload capability. Support inductor loads.

### Intelligent Function

- Support Max 6 pcs in parallel, capable of forming a three-phase system.
- Can be used with any battery (between 40V-60V).
- Supports multiple generator access methods and can control the start and stop of the generator.
- Smart load function achieves intelligent load shedding.
- AC coupling to upgrade existing PV plant without purchasing additional accessories.
- Customizable charge/discharge time settings.
- 290A maximum charge and discharge current.
- Multiple battery protection function.

### Safe&Reliable

- Safety protection with integrated AFCI function, which actively detects arc faults in the PV Array.
- Multiple battery protection function.

## 1.4 Packaging

Please ensure that the following items are included in the packaging with your machine:

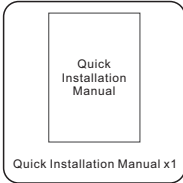
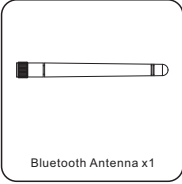
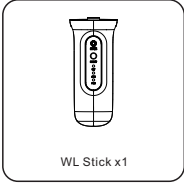
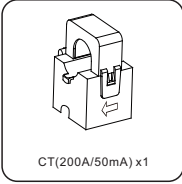
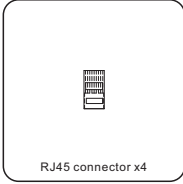
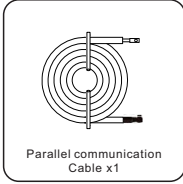
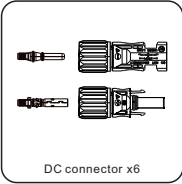
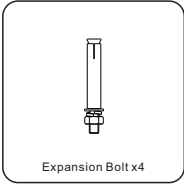
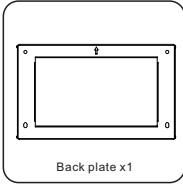

If anything is missing, please contact your local Solis distributor.

## 1.5 Tools Required for Installation



### 2.1 Safety

The following types of safety instructions and general information appear in this document as described below:



#### **DANGER**

“Danger” indicates a hazardous situation which if not avoided, will result in death or serious injury.



#### **WARNING**

“Warning” indicates a hazardous situation which if not avoided, could result in death or serious injury.



#### **CAUTION**

“Caution” indicates a hazardous situation which if not avoided, could result in minor or moderate injury.



#### **NOTE**

“Note” provides tips that are valuable for the optimal operation of your product.



#### **WARNING: Risk of fire**

Despite careful construction, electrical devices can cause fires.

- Do not install the inverter in an area containing flammable materials or gases.
- Do not install the inverter in a potentially explosive atmosphere.

### 2.2 General Safety Instructions



#### **WARNING**

Only devices in compliance with SELV (EN 69050) may be connected to the RS485 and USB interfaces.



#### **WARNING**

Do not connect PV array positive (+) or negative (-) to ground, doing so could cause serious damage to the inverter.



#### **WARNING**

Electrical installations must be done in accordance with local and national electrical safety standards.



#### **WARNING**

Do not touch any internal parts until 5 minutes after disconnection from the utility grid, PV array, and battery.



### WARNING

To reduce the risk of fire, over-current protective devices (OCPD) are required for all circuits connected to the inverter.

The DC OCPD shall be installed per local requirements. All photovoltaic source and output circuit conductors shall have isolators that comply with the NEC Article 690, Part II.

All Solis single phase inverters feature an integrated DC disconnect switch.



### CAUTION

Risk of electric shock, do not remove the cover. There are no serviceable parts inside, refer servicing to qualified and accredited service technicians.



### CAUTION

The PV conductors are energized with high voltage DC when the PV modules are exposed to sunlight.



### CAUTION

The surface temperature of the inverter can reach up to 75°C.

To avoid risk of burns, do not touch the surface of the inverter while it is operating. The inverter must be installed out of direct sunlight exposure.



### NOTE

PV modules used with inverter must have an IEC 61730 Class A rating.



### WARNING

Operations must be accomplished by a licensed electrician or a person authorized by Solis.



### WARNING

Installer must wear personal protective equipment during the entire installation process in case of electrical hazards.



### WARNING

The AC Backup Port of the inverter cannot be connected to the grid.



### WARNING

Please refer to the product manual of the battery before installation and configuration to the inverter.



**Systems using this product shall be designed and built in accordance with the NEC & local electrical codes & standards.**



**Please read safety instructions carefully in the manual.**



**CE certificate.**

### 2.3 Notice for Use

The inverter has been constructed according to the applicable safety and technical guidelines, use the inverter in installations that meet the following specifications only:

1. Permanent installation is required.
2. The electrical installation must be compliant with all local and national regulations & standards.
3. The inverter must be installed according to the instructions stated in this manual.
4. The inverter must be installed according to the inverter technical specifications.
5. The inverter contains an internal NEB that meets the requirements of NRS 097-2-1:2024 Section 5.4

### 2.4 Notice for Disposal

This product shall not be disposed of with household waste.

It must be segregated and brought to an appropriate disposal facility to ensure proper recycling.

This is to be done in order to avoid negative impacts on the environment and human health.

Local waste management rules shall be observed and respected.



## 3.1 Select a Location to Install the Inverter

When selecting a location for the inverter, the following criteria should be considered:

- Exposure to direct sunlight may cause output power derating due to overheating. It is recommended to avoid installing the inverter in direct sunlight. The ideal location is one where the ambient temperature does not exceed 40°C.
- It is also recommended to install the inverter somewhere the rain and snow will not land directly on it. The ideal installation location is on a north-facing wall under an eave.

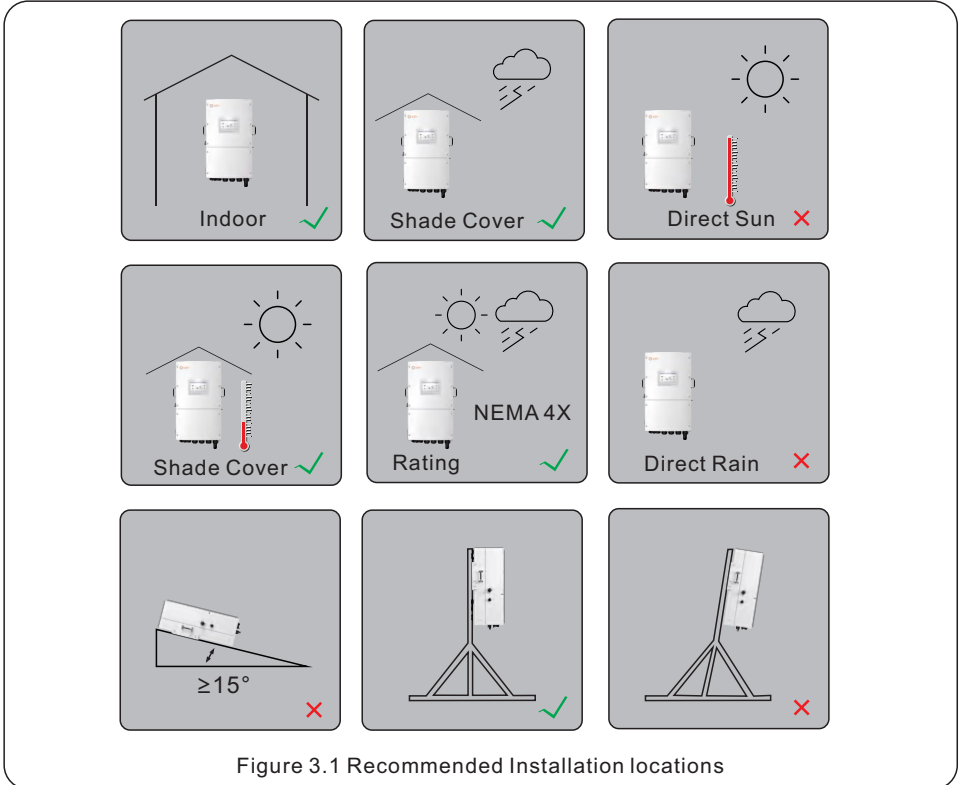

### **WARNING: Risk of fire**



Despite careful construction, electrical devices can cause fires.

- Do not install the inverter in areas containing highly flammable materials or gases.
- Do not install the inverter in potentially explosive atmospheres.
- The mounting structure where the inverter is installed must be fireproof.

When selecting a location for the inverter, consider the following:



**CAUTION: Hot Surface**

- The temperature of the inverter heat-sink can reach 75°C.

The ambient temperature and relative humidity of the installation environment should meet the following requirements:

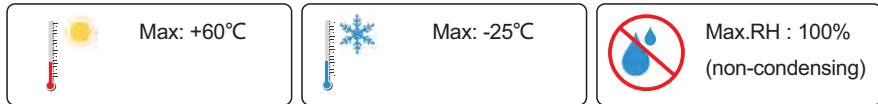

Figure 3.2 Installation environment conditions



**Load bearing surface:**

Made of non-inflammable materials

Max. load bearing capacity  $\geq$  4 times of inverter weight



Figure 3.3 Load bearing structure

### 3.1.1 Clearances

- If multiple inverters are installed on site, a minimum clearance of 1000mm should be kept between each inverter and all other mounted equipment. The bottom of the inverter should be at least 800mm above of the ground or floor.
- The LCD screen located on the inverter's front panel should not be blocked
- Adequate ventilation must be present if the inverter is to be installed in a confined space.

### 3.1.2 Consult technical data

- Consult the technical specifications sections at the end of this manual for additional environmental condition requirements (temperature range, altitude, etc.)

### 3.1.3 Angle of installation

- This model of Solis inverter must be mounted vertically (90 degrees or backwards less than or equal to 15 degrees from 90 degrees straight up).

### 3.1.4 Avoiding direct sunlight

Installation of the inverter in a location exposed to direct sunlight should to be avoided.

Direct exposure to sunlight could cause:

- Power output limitation (with a resulting decreased energy production by the system).
- Premature wear of the electrical/electromechanical components.
- Premature wear of the mechanical components (gaskets) and user interface.

### 3.1.5 Air circulation

Do not install in small, closed rooms where air cannot freely circulate.

To prevent overheating, always ensure that the air flow around the inverter is not blocked.

### 3.1.6 Flammable substances

Do not install near flammable substances. Maintain a minimum distance of three meters (10 feet) from such substances.

### 3.1.7 Living area

Do not install in a living area where the prolonged presence of people or animals is expected.

Depending on where the inverter is installed (for example: the type of surface around the inverter, the general properties of the room, etc.) and the quality of the electricity supply, the sound level from the inverter can be quite high.

## 3.2 Product Handling

Please review the instruction below for handling the inverter:

1. The red circles below denote cutouts on the product package.

Push in the cutouts to form handles for moving the inverter (see Figure 3.4).

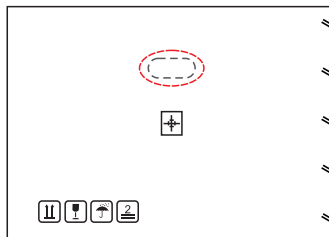

Figure 3.4 Handles used to move the inverter shown circled in red - one per side

2. Two people are required to remove the inverter from the shipping box. Use the handles integrated into the heat sink to remove the inverter from the carton.
3. When setting the inverter down, do it slowly and gently. This ensures that the internal components and the outer chassis do not take any damage.

## 3.3 Mounting the Inverter

- Mount the inverter on a wall or structure capable of bearing the weight of the machine.
- The inverter must be mounted vertically with a maximum incline of +/- 5 degree. Exceeding this may cause the output power to derate.
- To avoid overheating, always make sure the flow of air around the inverter is not blocked. A minimum clearance of 1000mm should be kept between inverters or objects and 800mm clearance between the bottom of the machine and the ground.

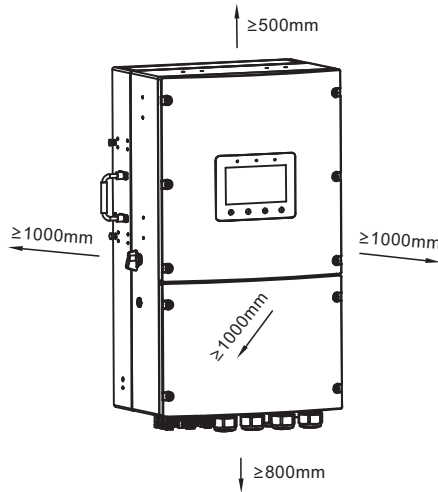

Figure 3.5 Inverter Mounting Clearances

- Visibility of the LCD screen should be considered.
- Adequate ventilation around the inverter must be provided.



**NOTE**

Nothing should be stored on top of or placed against the inverter.



**NOTE**

It is prohibited to install two units in one line up and down.



**NOTE**

If there is heat source device such as the battery cabinet under the inverter, it is recommended to install it at a distance of not less than 800mm. If there is no heat source, the minimum spacing at the bottom is 500mm.

Dimensions of mounting bracket:

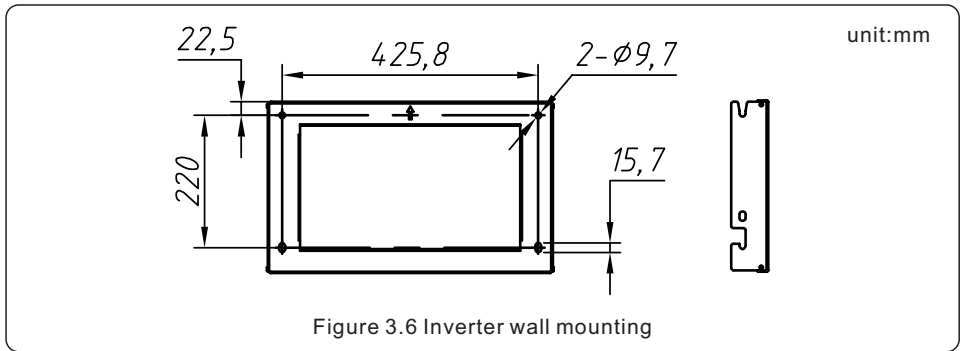

Once a suitable location has been found according to 3.1 using figure 3.6 mount the wall bracket to the wall.

The inverter shall be mounted vertically.

The steps to mount the inverter are listed below:

1. Select the mounting height of the bracket and mark the mounting holes.  
For brick walls, the position of the holes should be suitable for the expansion bolts.
2. Lift up the inverter (be careful to avoid body strain), and align the back bracket on the inverter with the convex section of the mounting bracket. Hang the inverter on the mounting bracket and make sure the inverter is secure (see Figure 3.7)

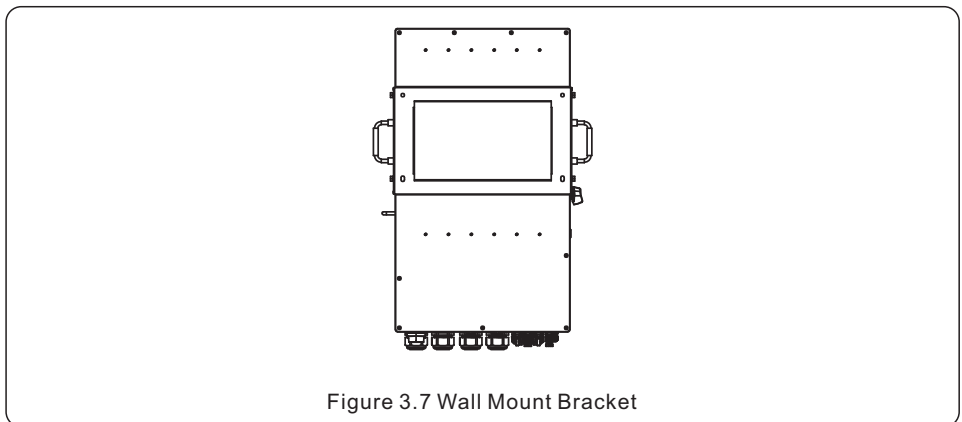

**WARNING:**

The inverter must be mounted vertically.

## 3.4 Inverter Wiring Overview

	Purpose	Connection Points
PV Cables	PV DC connection to the inverter	From the PV array to the DC+ and DC- terminals in the inverter
Battery Cables	Battery DC connection to the inverter	From the battery (+) and (-) terminals to the inverter BAT+ and BAT- terminals
AC Grid Cables	Inverter AC connection to the main service panel	From the OCPD in the main service panel to the AC-GRID L1 and L2 terminals
AC Backup Cables	Inverter AC connection to the backup subpanel	From the backup loads subpanel OCPD to the inverter AC-BACKUP L1 and L2 terminals
Ground Cables	Grounding conductors for the system	From the main service panel ground bar to the ground bar inside the inverter wire box
CT cable	Communication between inverter & CT	From CT to terminal HM. For more details, refer to figure Installing the energy meter
Battery CAN cable	Communication between the inverter & the battery	From battery to terminal BMS. For more details, refer to figure Installing the battery
Data Logger	Monitoring of the system on SolisCloud	USB COM port at the bottom of the inverter (For more details, please refer to the Solis data logger product manual)



**NOTE**

Conductor dimensions and OCPD sizing to be determined in accordance with the national electrical code (NEC) and local standards.

## 3.5 Ground Cable Installation

External ground connections are provided at the left and right sides of the inverter. Prepare OT terminals: M4. Use proper tooling to crimp the lug to the terminal. Connect the OT terminal with ground cable to the right or left side of inverter.

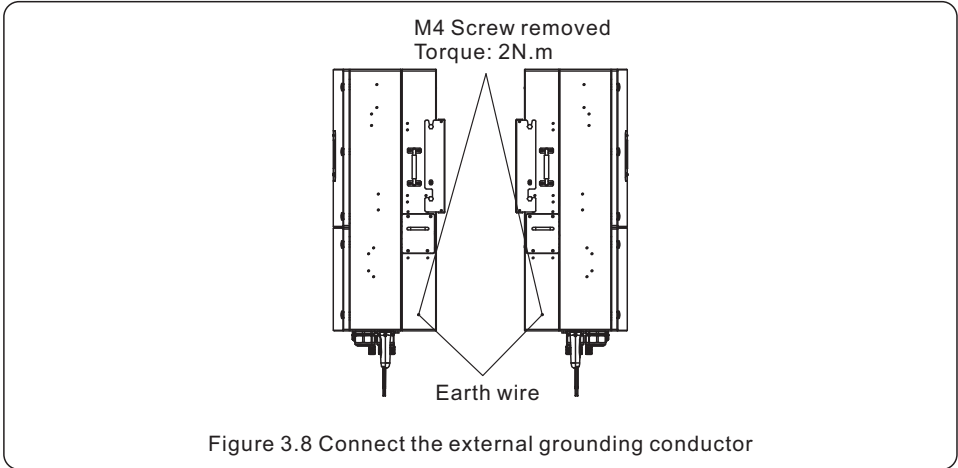

To connect the grounding terminal on the heat sink, please follow the steps below:

1. It is recommended to use copper wire for the chassis ground. Either solid conductor or stranded wire is acceptable. Refer to local code standard for wire sizing.
2. Attach OT terminal: M4.



### IMPORTANT

For multiple inverters in parallel, all inverters should be connected to the same ground point to eliminate the possibility of a voltage potential existing between inverter grounds.

3. Strip the ground cable insulation to a suitable length. (see Figure 3.9)
4. Crimp a ring connector onto the cable and then connect it to the chassis ground terminal.

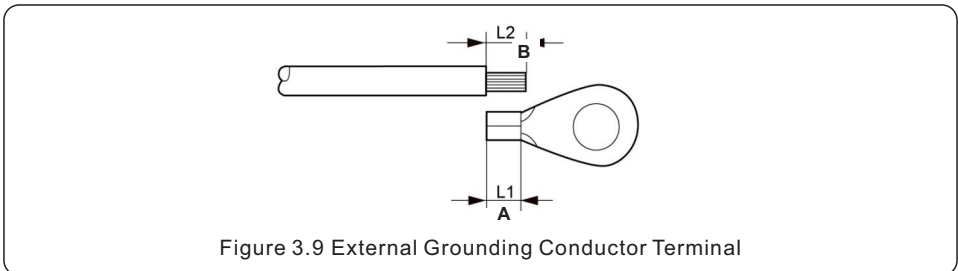

5. The external grounding conductor is recommended to be connected to 4mm<sup>2</sup> and above.

## 3.6 PV Cable Installation



Before connecting inverter, please make sure the PV array open circuit voltage is within the limit of the inverter.



Before connection, please make sure the polarity of the output voltage of PV array matches the "DC+" and "DC-" symbols.



Please use approved DC cable for PV system.

1. Select a suitable DC cable and strip the wires out by  $7\pm 0.5\text{mm}$ . Please refer to the table below for specific specifications.

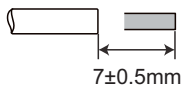

Cable type	Cross section (mm <sup>2</sup> )	
	Range	Recommended value
Industry generic PV cable	4.0~6.0 (12~10AWG)	4.0 (12AWG)

Figure 3.10

2. Take the DC terminal out of the accessory bag, turn the screw cap to disassemble it, and take out the waterproof rubber ring.

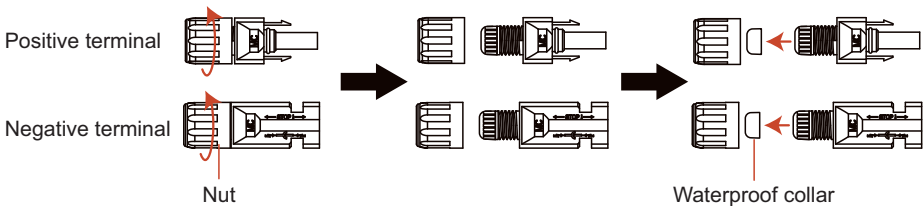
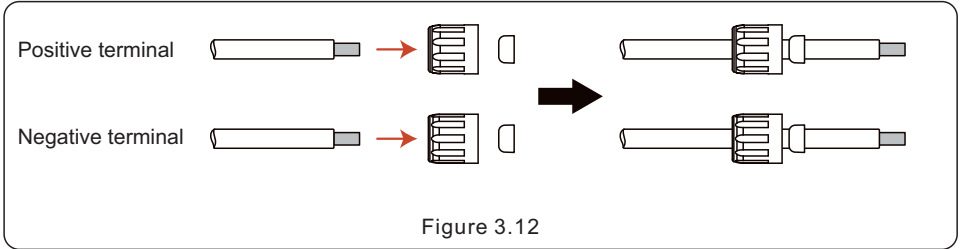
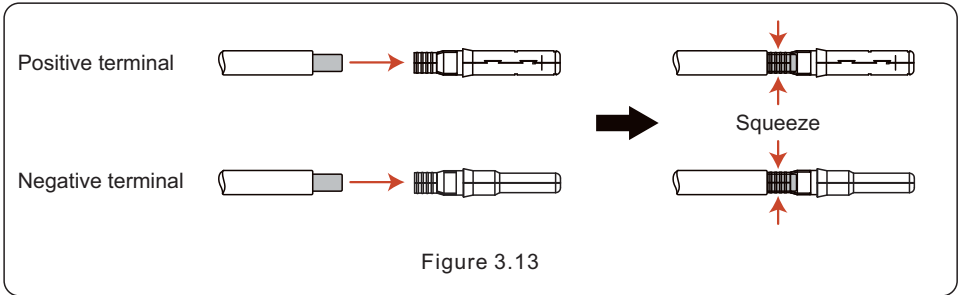

Figure 3.11

3. Pass the stripped DC cable through the nut and waterproof rubber ring.



4. Connect the wire part of the DC cable to the metal DC terminal and crimp it with a special DC terminal crimping tool.



5. Insert the crimped DC cable into the DC terminal firmly, then insert the waterproof rubber ring into the DC terminal and tighten the nut.

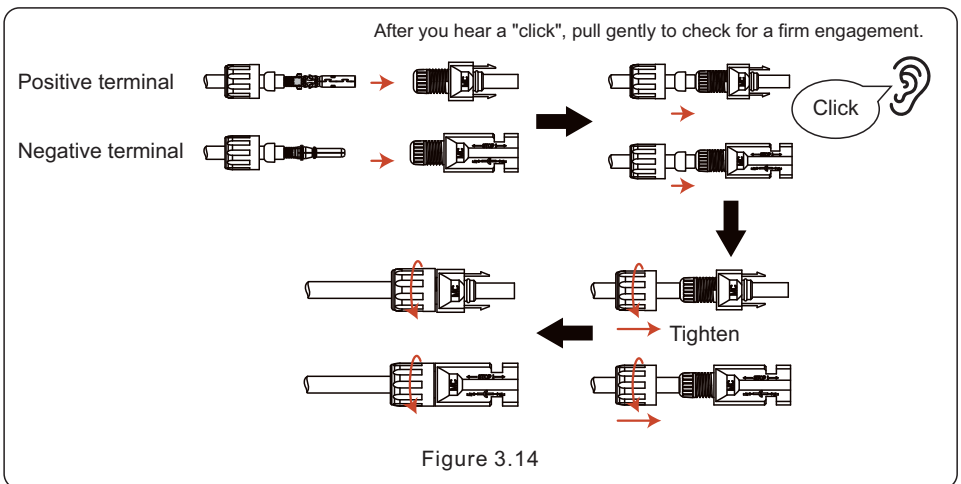

6. Measure PV voltage of DC input with multimeter, verify DC input cable polarity.

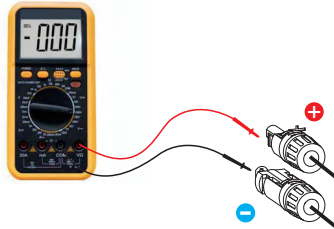

Figure 3.15

7. Connect the wired DC terminal to the inverter as shown in the figure, and a slight "click" is heard to prove the connection is correct.

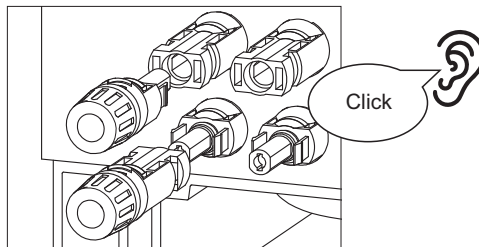

Figure 3.16



**CAUTION:**

If DC inputs are accidentally reversely connected or inverter is faulty or not working properly, it is NOT allowed to turn off the DC switch. Otherwise it may cause DC arc and damage the inverter or even lead to a fire disaster. The correct actions are:

- \*Use a clip-on ammeter to measure the DC string current.

- \*If it is above 0.5A, please wait for the solar irradiance reduces until the current decreases to below 0.5A.

- \*Only after the current is below 0.5A, you are allowed to turn off the DC switches and disconnect the PV strings.

- \* In order to completely eliminate the possibility of failure, please disconnect the PV strings after turning off the DC switch to avoid secondary failures due to continuous PV energy on the next day.

Please note that any damages due to wrong operations are not covered in the device warranty.

## 3.7 Battery Cable Installation



**DANGER**

Before installing the battery cables, be sure that the battery is turned off. Use a multimeter to verify that the battery voltage is 0Vdc before proceeding. Consult the battery product manual for instructions on how to turn it off.

1. The battery (+) and (-) cables shall only be connected to the inverter BAT terminals.
2. Run the cables into the wire box. Strip 13mm off the ends of each cable.
3. Crimp the R-type connectors onto the cables. Do not over crimp the connectors.
4. Remove the terminal bolts and then insert them through the connector holes.
5. Put each bolt back into the proper place, be sure to not reverse the polarity.
6. Tighten the bolts with a torque wrench screwdriver following the torque specs.
7. Battery circuit breaker specification: 200A\_80Vdc\_2P\_7500A\_UL489.

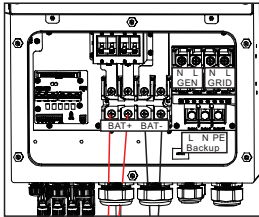

Cable type	Terminal	Recommended cable
Battery cable	M8 screws*4	2AWG*4

Figure 3.17 Battery cable connection



**NOTE**

The current of each battery input must be less than 200A. When reaching or exceeding 200A, two battery inputs must be connected. The maximum total current of the two batteries is 290A.



**NOTE**

Before connecting the battery, please carefully read the product manual of the battery and perform the installation exactly as the battery manufacturer specifies in the manual



**NOTE**

Please use the battery that has been matched by Solis. Please see the battery matching list on the Solis official website. If the battery is not in the list, our company will not carry out after-sales maintenance.

## 3.8 AC Wiring



**DANGER**

Before installing the AC cables, be sure that the OCPDs (breakers) are turned off.

Use a multimeter to verify that the AC voltages are 0Vac before proceeding.

There are three sets of AC output terminals and the installation steps for both are the same.

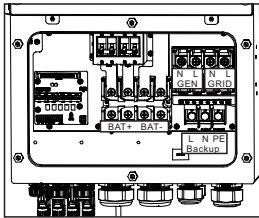

Model	AC Grid	AC Backup/AC Gen	PE
Wire Size	25-35mm <sup>2</sup>	16-25mm <sup>2</sup>	16-25mm <sup>2</sup>
Torque	4.5N.m	4.5N.m	4.5N.m

Figure 3.18 AC output terminals

1. Bring the AC cables for the backup loads panel (backup) and the main service panel (grid) into the inverter wire box. The backup loads panel should not be electrically connected to the main service panel.
2. Strip 13mm from the ends of each cable. Crimp the R-type connectors onto the ends.
3. Remove the terminal bolts, insert them into the connectors, then use a torque wrench to tighten the bolts down.
4. Please refer to the terminal labels to connect the AC wires to the correct terminals.



**NOTE:**

The suggested specification external AC breakers are as following.

AC grid port: 150A

Backup port: 100A

Gen port: 100A

Battery port: 350A

The temperature limit of wiring terminals for external connections should be lower than 105°C.



**NOTE:**

1. The backup PE must be directly connected to the PE copper bar of the power distribution box, rather than the inverter shell.

2. The generator itself needs to be grounded, connected to the electric box, and connected to the inverter generator port.

3. When the generator is working, disconnect the Grid breaker or leakage current protector on the side of the power box immediately.

## 3.9 CT Connection



**CAUTION:**

Make sure the AC cable is totally isolated from AC power before connecting the CT.

The CT provided in the product box is compulsory for hybrid system installation. It can be used to detect the grid current direction and provide the system operating condition to hybrid inverter.

CT Model: ESCT-TA24-200A/50mA(5m)

CT cable: Length —5m

Please install the CT on the hot line at the system grid connection point and the arrow on the CT needs to point to the grid direction.

Lead the CT wires through the COM3 port at the bottom of the inverter and connect the CT wires to the 12pin communication terminal block.

CT Wire	12 PIN Communication Terminal Block
White	Pin 9 (From Left to Right)
Black	Pin 10 (From Left to Right)

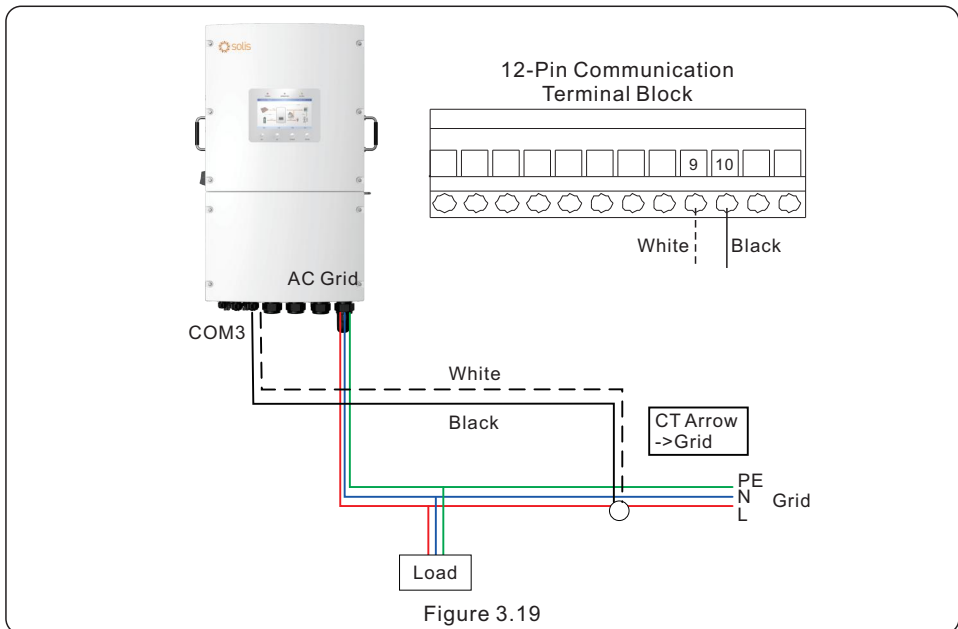

## 3.10 Inverter Communication

### 3.10.1 Communication Ports

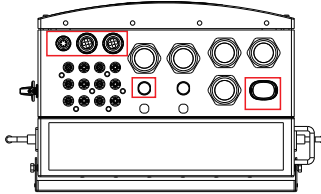

Port	Port Type	Description
COM1	USB	Used for Solis data logger connection
ANTENNA	Antenna	Used for Antenna connection for built in Bluetooth signal
COM2	4 hole watertight cable gland	Used for RJ45 connection inside wiring box
COM3	4 hole watertight cable gland	Used for RJ45 connection inside wiring box
COM4	6 hole watertight cable gland	Used for 12 PIN terminal block connection inside wiring box

Wiring steps for COM2-COM4:

Step 1. Loose the cable gland and remove the watertight caps inside the cable gland based on the number of the cables and keep the unused holes with watertight cap.

Step 2. Lead the cable into the holes in the cable gland.

(COM2-COM3 Hole Diameter: 6mm, COM4 Hole Diameter: 2mm)

Step 3. Connect the cable to the corresponding terminals inside the wiring box.

Step 4. Reassemble the cable gland and ensure there is no bending or stretching of the cables inside the wiring box.



**NOTE:**

The 4-hole fastening rings inside the cable gland for COM2 and COM3 are with openings on the side.

Please separate the gap with hand and squeeze the cables into the holes from the side openings.

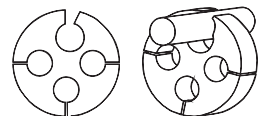

## 3.10.2 Communication Terminals

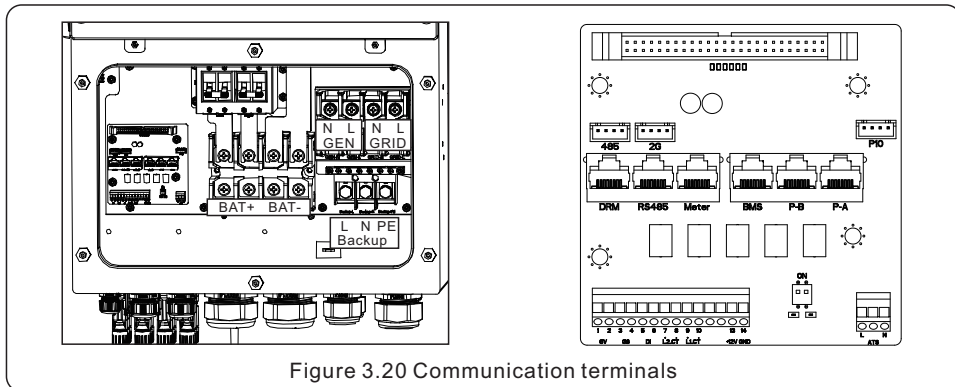

Figure 3.20 Communication terminals

Terminal	Type	Description
BMS	RJ45	Used for CAN communication between inverter and Lithium battery BMS. Used for Battery temperature sensor between inverter and lead-acid battery.
Meter		(Optional)Used for RS485 communication between inverter and the smart meter.
DRM		(Optional) To realize Demand Response or Logic Interface function, this function may be required in UK and Australia.
RS485		(Optional) Used for Modbus RTU communication with 3rd party external device or controller.
P-A		(Optional) Parallel operation communication port.
P-B		(Optional) Parallel operation communication port.
DIP Switch (2-1)	-	When a single inverter is running, DIP switch 1 and 2 shall be both at the bottom position. When multiple inverters are paralleled, DIP switch: Option 1: Both the first and last inverter (INV1 & INV3) have 1 of the DIP switch enabled (Either Pin1 or Pin2). Option 2: One of the first and the last inverter (INV1 or INV3) has 2 DIP switches enabled (Both Pin1 & Pin2)
GV	Terminal Block	Pin 1 and pin 2 (from left to right) are used for the generator start-stop.
DI		Pin 5 & Pin 6 (from left to right) are used for the generator start-stopsignal when the generator is connected to the grid side.
CT		Pin 9 & Pin 10 (from left to right) are used for CT wire connection.

### 3.10.3 BMS Terminal Connection

#### 3.10.3.1 With Lithium Battery

CAN communication is supported between inverter and compatible battery models. Please lead the CAN cable through the COM1 or COM2 port of the inverter and connect to the BMS terminal with RJ45 connector.

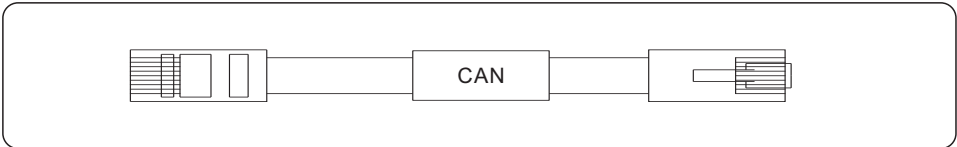

**NOTE:**



Before connecting CAN cable with the battery, please check whether the communication pin sequence of the inverter and the battery match; If it does not match, you need to cut off the RJ45 connector at one end of the CAN cable and adjust the pin sequence according to the pin definitions of both inverter and battery.

Pin definition of the inverter BMS Port is following EIA/TIA 568B.

CAN-H on Pin 4: Blue

CAN-L on Pin 5: Blue/White

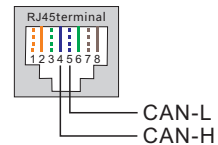

#### 3.10.3.2 With Lead-acid Battery

When Lead-acid battery is used, battery temperature sensor needs to be connected to the BMS terminal of the inverter.

Step 1. Take out the battery temperature sensor cable and lead through the COM1 or COM2 port of the inverter and connect the RJ45 connector to the BMS terminal.

Step 2. Fasten the temperature sensor ring onto the battery module. If no suitable fastening terminal can be found on the battery module, the sensor ring can be attached to the positive or negative pole of the battery module.

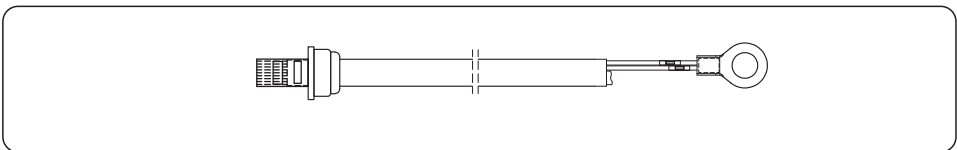

### 3.10.4 Meter Terminal Connection (Optional)

If a smart meter is preferred to be installed other than the provided CT, please contact Solis sales rep to order the smart meter and corresponding meter CT.

Please lead the Meter RS485 cable through the COM1 or COM2 port of the inverter and connect to the Meter terminal with RJ45 connector.



**NOTE:**

Pin definition of the Meter Terminal is following EIA/TIA 568B.

RS485A on Pin 1: Orange/white

RS485B on Pin 2: Orange

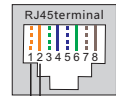

RS485B  
RS485A



**NOTE:**

Compatible Smart Meter Pin Definition.

SDM120CTM (With CT) – Pin 9 is RS485B & Pin 10 is RS485A

## 3.10.5 DRM Port Connection (Optional)

### 3.10.5.1 For Remote Shutdown Function

Solis inverters support remote shutdown function to remotely control the inverter to power on and off through logic signals.

The DRM port is provided with an RJ45 terminal and its Pin5 and Pin6 can be used for remote shutdown function.

Signal	Function
Short Pin5 and Pin6	Inverter Generates
Open Pin5 and Pin6	Inverter Shutdown in 5s

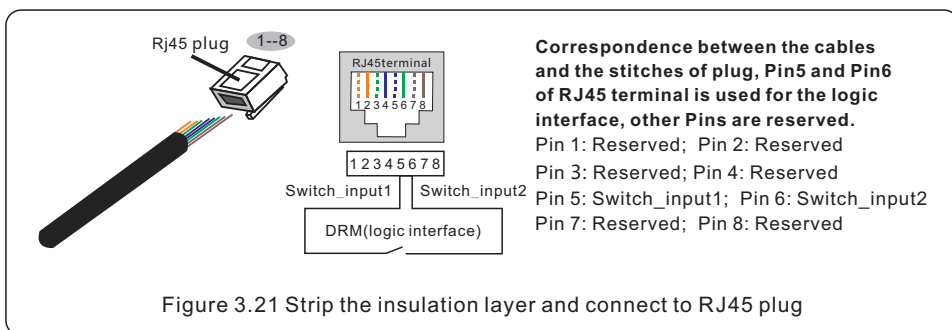

### 3.10.5.2 For DRED Control Function (For AU and NZ Only)

DRED means demand response enable device. The AS/NZS 4777.2:2020 required inverter need to support demand response mode(DRM).

This function is for inverter that comply with AS/NZS 4777.2:2020 standard.

A RJ45 terminal is used for DRM connection.

Pin	Assignment for inverters capable of both charging and discharging	Pin	Assignment for inverters capable of both charging and discharging
1	DRM 1/5	5	RefGen
2	DRM 2/6	6	Com/DRM0
3	DRM 3/7	7	V+
4	DRM 4/8	8	V-



**NOTE:**

Solis hybrid inverter is designed to provide 12V power for DRED.

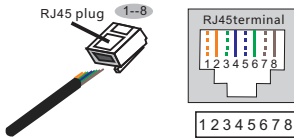

**Correspondence between the cables and the stitches of plug**  
 Pin 1: white and orange ; Pin 2: orange  
 Pin 3: white and green; Pin 4: blue  
 Pin 5: white and blue; Pin 6: green  
 Pin 7: white and brown; Pin 8: brown

Figure 3.22 Strip the insulation layer and connect to RJ45 plug

### 3.10.6 RS485 Port Connection (Optional)

If a 3rd party external device or controller needs to communicate with the inverter, the RS485 port can be used. Modbus RTU protocol is supported by Solis inverters.

To acquire latest protocol document, please contact Solis local service team or Solis sales.



**NOTE:**  
 Pin definition of the RS485 Port is following EIA/TIA 568B.  
 RS485A on Pin 5: Blue/White  
 RS485B on Pin 4: Blue

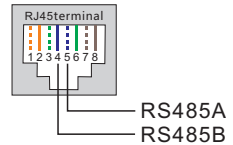

### 3.10.7 Parallel Terminal Connection (Optional)

Up to 6 units of the inverter can be connected in parallel.

Please connect the paralleled inverters in daisy chain by using P-A and P-B terminals.

Standard CAT5 with shielding layers internet cable can be used.

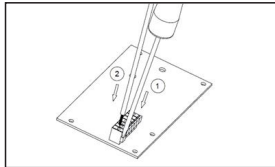

Figure 3.23 Parallel Terminal Connection

### 3.10.8 12-pin Communication Terminal Block

Terminal Block Connection Steps:

- Step 1. Lead the wires through the hole in COM3 port (Hole Diameter: 2 mm)
- Step 2. Strip the wires for 9mm length
- Step 3. Use slot type screwdriver to press the block on the top
- Step 4. Insert the exposed copper part of the cable into the terminal.
- Step 5. Remove the screwdriver and the terminal will clamp down on the exposed copper part.
- Step 6. Give the cable a gentle tug to ensure that it is firmly secured.



#### 3.10.8.1 CT Terminal Connection

CT connection is necessary to realize the correct control logic of the hybrid inverter, unless the smart meter is used as stated in section 3.10.4 and section 3.9.

The CT provided in the inverter package has BLACK(S2) and WHITE(S1) wires. The BLACK wire needs to connect to the Pin 10 of the terminal block and the WHITE wire needs to connect to the Pin 9 of the terminal block as in the following diagram.

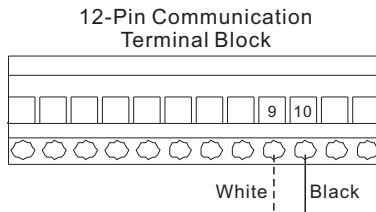

Figure 3.24

### 3.10.8.2 G-V Terminal Connection

The G-V terminal is a voltage-free dry contact signal for connecting with generator's NO relay to start up the generator when necessary.

When generator operation is not needed, Pin1 and Pin2 is in open circuit.

When generator operation is needed, Pin1 and Pin2 is in short circuit.

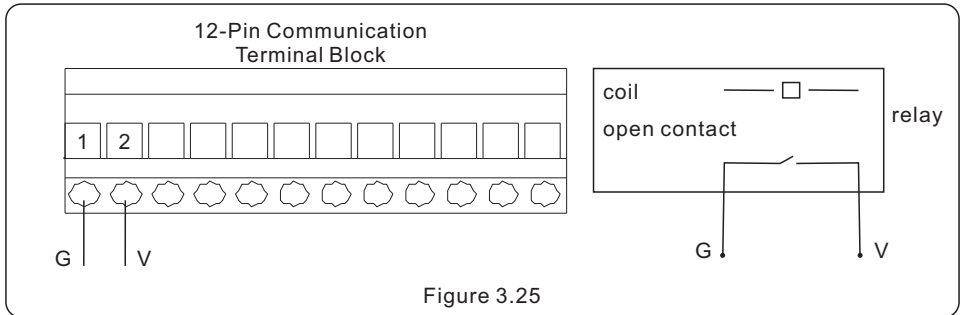

## 3.11 Inverter Remote Monitoring Connection

The inverter can be remotely monitored via WiFi, LAN or 4G.

The USB type COM port at the bottom of the inverter can connect to different kinds of Solis data loggers to realize the remote monitoring on Soliscloud platform.

To install Solis data loggers, please refer to corresponding user manuals of Solis data loggers.

The Solis data loggers are optional and can be purchased separately.

Dust cover is provided the inverter package in case the port is not used.



**WARNING:**

The USB type COM port is only allowed to connect Solis data loggers. It is forbidden to be used for other purposes.

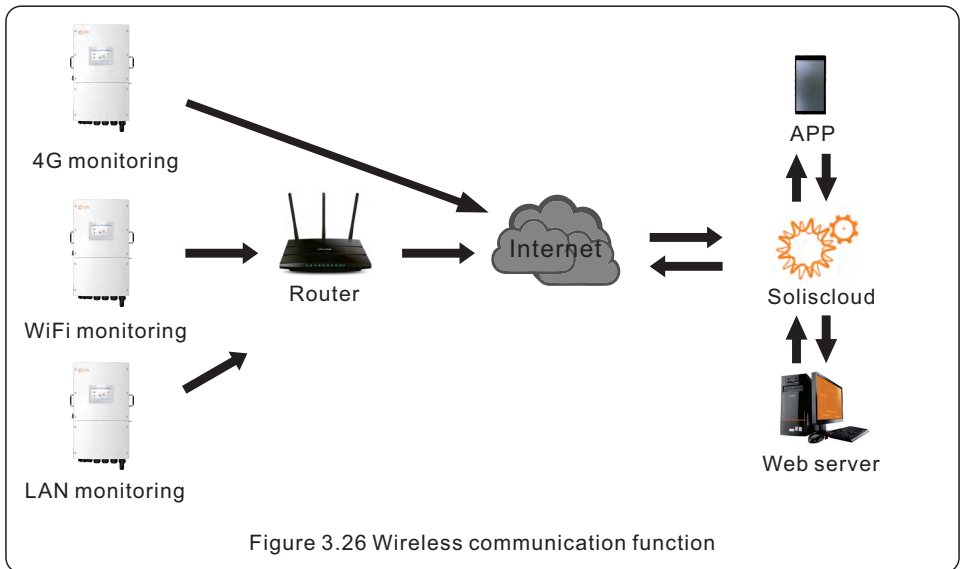
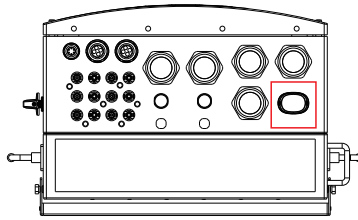

## 3.12 Wiring Diagram Overview

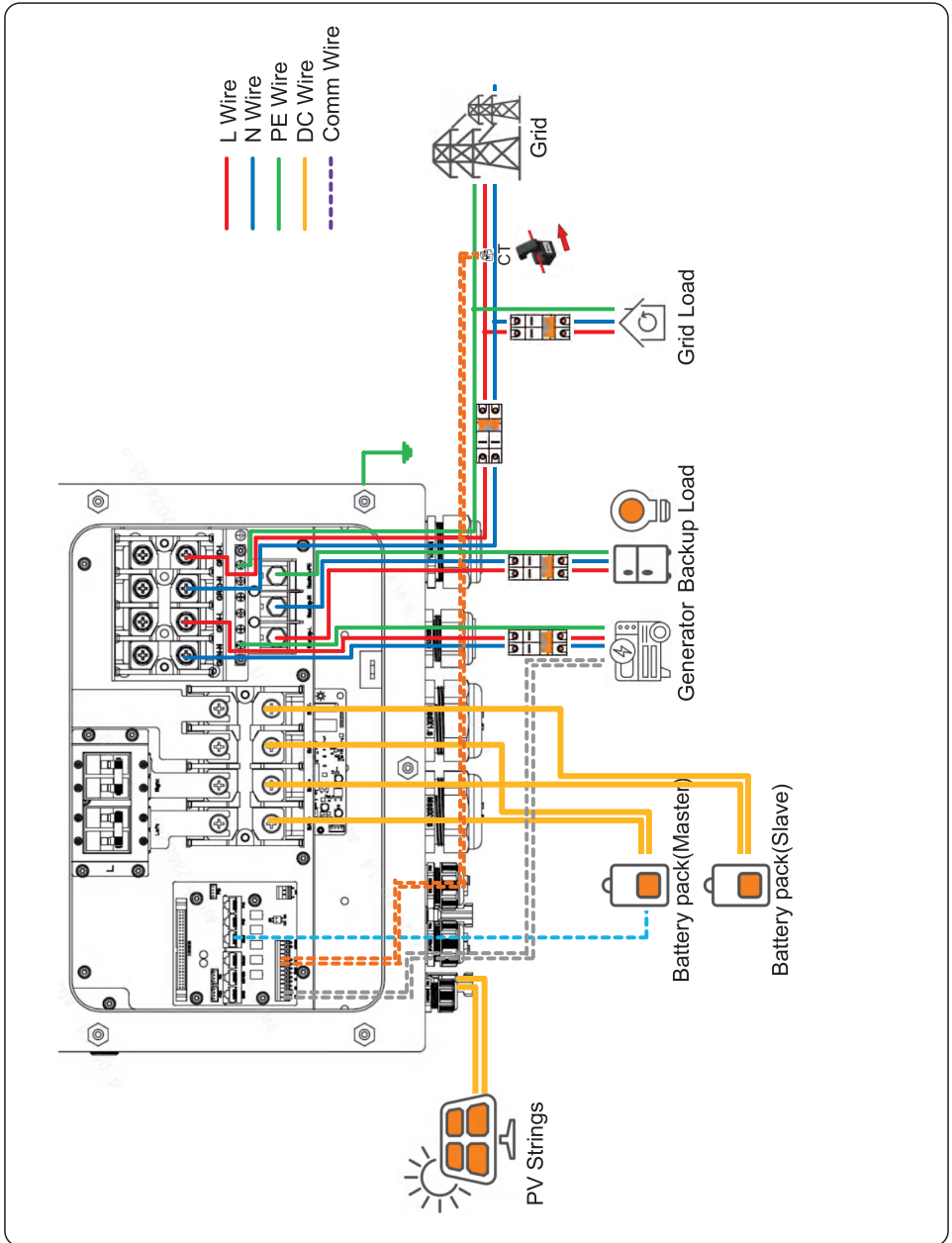

## 3.13 Parallel System Wiring Diagram

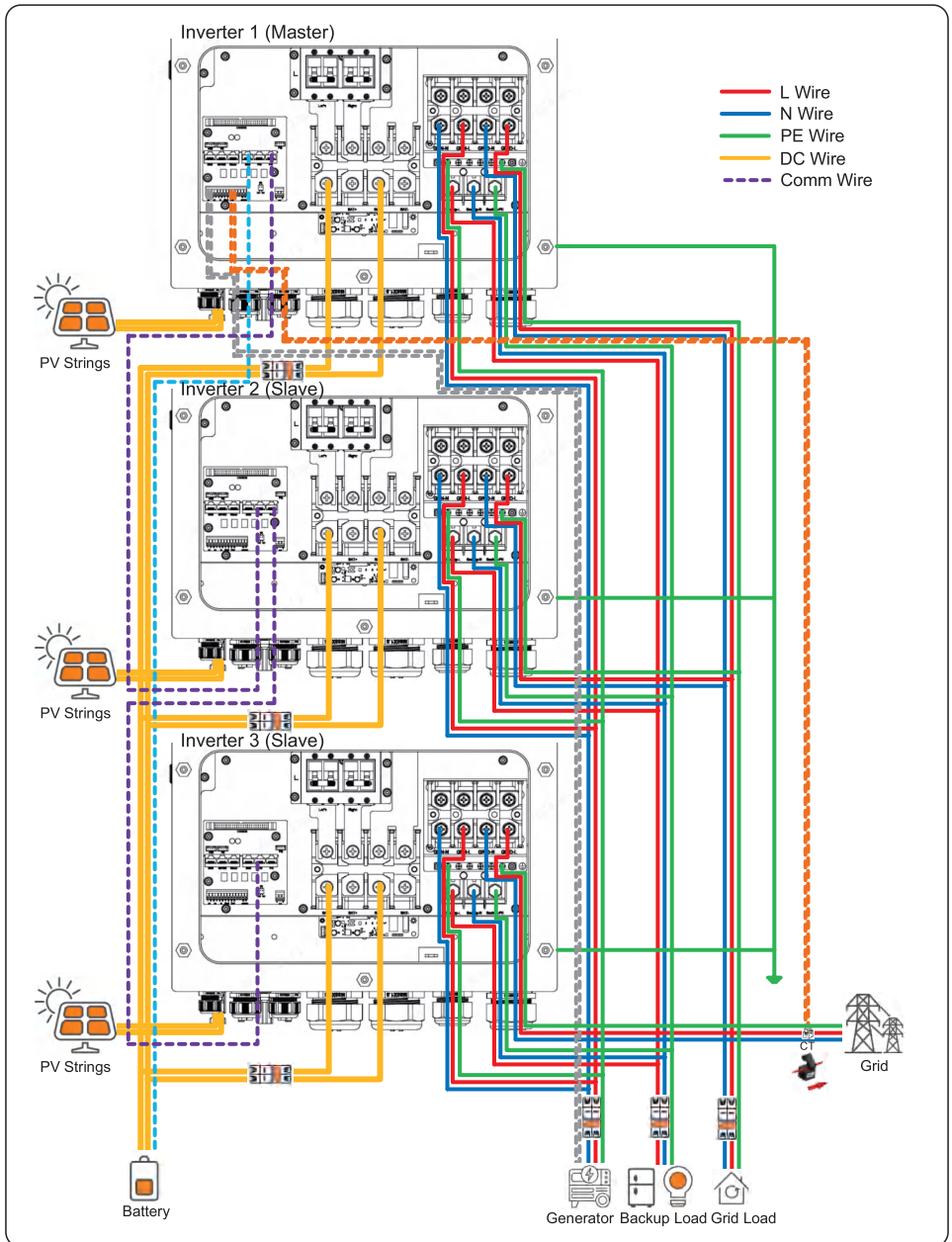

## 4.1 Screen

Solis S6 Series adopts 7 inch color screen, it displays the status, operating information and settings of the inverter.

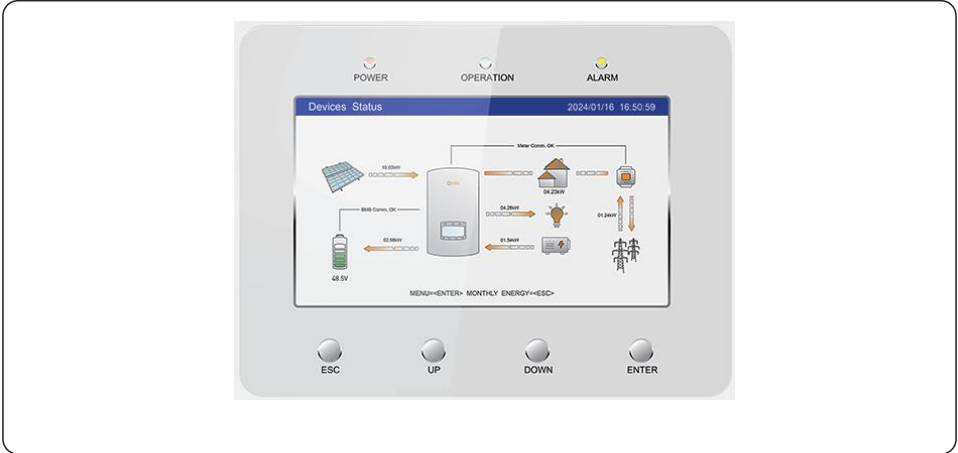

## 4.2 LED Indicators

There are three LED indicators on the inverter (Red, Green, and Orange) which indicate the working status of the inverter.



Light	Status	Description
● POWER	ON	The inverter can detect power supply.
	OFF	No power.
● OPERATION	ON	The inverter is fully operational.
	OFF	The inverter has stopped operating.
	FLASHING	The inverter is initializing.
● ALARM	ON	The inverter has detected the emergency fault.
	OFF	The inverter has not detected any faults.
	FLASHING	The inverter has detected the normal fault or warning.

Table 4.1 Status Indicator Lights

## 4.3 Keypad

There are four keys in the front panel of the inverter (from left to right): ESC, UP, DOWN and ENTER keys. The keypad is used for:

- Scrolling through the displayed options (the UP and DOWN keys);
- Access and modify the settings (the ESC and ENTER keys).



Figure 4.1 Keypad



**NOTE:**

The screen will be automatically turn off after being idle for a few minutes to save power, click any operation button (“ESC”/“UP”/“DOWN”/ “ENTER”) to restart the screen, then press“Enter”into the main operation interface.

## 4.4 Inverter built-in Bluetooth description

Blueooth: BDR、EDR、BLE

frequency band(s) in which the radio equipment operates:2.402-2.480GHZ

Maximum transmitting power: 8dBm

Hereby, Ginlong Technologies Co.,Ltd.declares that the radio equipment type hybrid inverter is in compliance with Directive 2014/53/EU

## 5.1 Pre-Commissioning

- Make sure that no high voltage conductors are energized.
- Check all conduit and cable connection points ensure they are tight.
- Verify that all system components have adequate space for ventilation.
- Follow each cable to ensure that they are all terminated in the proper places.
- Ensure that all warning signs and labels are affixed on the system equipment.
- Verify that the inverter is secured to the wall and is not loose or wobbly.
- Prepare a multimeter that can do both AC and DC amps.
- Have an Android or Apple mobile phone with Bluetooth capability.
- Install the Soliscloud APP on the mobile phone and register a new account.
- There are three ways to download and install the latest APP.

- 1.You can visit [www.soliscloud.com](http://www.soliscloud.com).
- 2.You can search"Soliscloud" in Google Play or APP Store.
- 3.You can scan this QR code to download Soliscloud.



## 5.2 Power ON

Step 1: With the DC switch off, energize the PV strings and then measure DC voltage of the PV strings to verify that the voltage and polarity are correct. Turn on the battery and check the battery voltage and polarity as well.

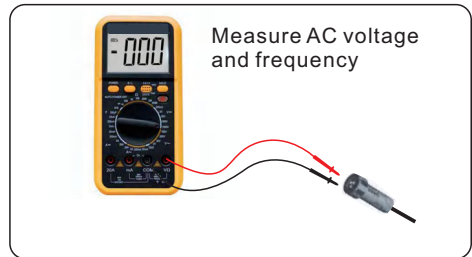
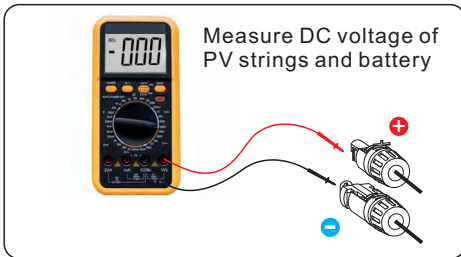

Step 2: Turn on the OCPD for the system and then measure the AC voltages line to line and line to neutral. The backup side of the system will be off until commissioning is complete. Turn the OCPD back off for now.

Step 3: Turn the DC switch on and then the OCPD(AC breaker) for the system. This inverter can be powered on by PV only, battery only and Grid only. When the inverter is powered on,the five indicators will be lighted at once.

## 5.3 Power OFF

- Step 1: Turn off the AC breaker or AC disconnect switch to disable AC power to the inverter.
- Step 2: Turn off the DC switch of the inverter.
- Step 3: Turn off the battery breaker.
- Step 4: Use a multimeter to verify that the battery and AC voltages are 0V.

## 5.4 HMI Screen Setting

### 5.4.1 HMI Quick Setting

If this is the first time the inverter has been commissioned, you will need to first go through the Quick Settings. Once this has been done, these settings can be changed later.

**Inverter Time -> Meter Setting -> Grid Code -> Storage mode -> Battery Model**

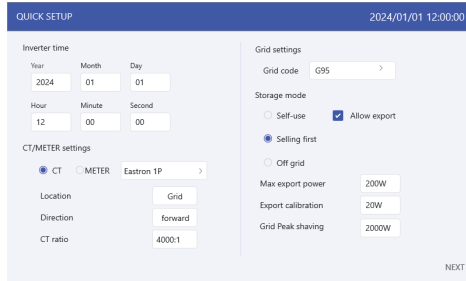

#### 1. Inverter time:

Set inverter time and date.

#### 2. CT/Meter setting:

Select the CT or Meter, Solis provide ESCT-TA16-100A/50mA CT as standard, and customers can select the meter as an option. If there is no meter connected for the moment, please select "No Meter" to avoid alarms.

Location: Default Grid side.

Direction: Default Forward. The CT installation direction is towards the grid.

CT ratio: Default 2000:1. If the system connected to Meter, then CT ratio need to be set on Meter.

#### 3. Grid code:

Select grid code that meet the local regulations.

#### 4. Storage mode:

All modes first priority is to use the available PV power to power loads. The different modes determine the second priority, which is whether to use excess PV power to charge the battery or feed the grid.

Self-use/Selling first/off grid are exclusive, and users can only select one mode.

Mode	Description
Self-use	<p>PV power consumption priority: load &gt; battery &gt; grid. In this mode, The PV power supplies to the load preferentially, and the excess power is charged to the battery.</p> <p>If "Allow export" enabled, when the battery is fully charged, or there is no battery, the excess PV power will feed the grid.</p> <p>If "Allow export" disabled, then the inverter will curtail the PV power according to the power of the load.</p>
Selling first	<p>PV power consumption priority: load &gt; grid &gt; battery. In this mode, The PV power supplies to the load preferentially, and the excess power will feed the grid. If the export power quota has been met, the excess PV power will charge the battery.</p> <p>Note: This mode should not be used if export power set to zero.</p>
Off grid	<p>PV power consumption priority: load &gt; battery. This mode applies the area not covered by the grid or the system is not connected to the grid. When the power outage is detected, the system will automatically enter the off-grid mode, supplying only the backup load.</p>

Table 1 Description of modes

Under each mode, user could set other functions based on their requirements.

Settings	Description
Max export power	Limit the maximum power sold to the grid.
Export calibration	Range : -500w-500w, default 20w, settable. To compensate the deviation of CT/Meter in practical application.
Grid peak shaving	<p>Default enable, default 2 times of rated power. Limit the power drawn from the grid to prevent from exceeding regulatory requirements or the power line capacity. When the grid supplies power to the load while charging the battery, it will limit the power used to charge the battery, so that the total power does not exceed the set value. If the grid only supplies power to the load and does not charging the battery, it is not limited by the setting value.</p>

Table 2 Description of mode settings

## 5. Battery setting:

If the connected communication lithium battery is on the battery matching list but not found in the model list, you need to select Lithium Battery LV.

Set Max charging/discharging current.

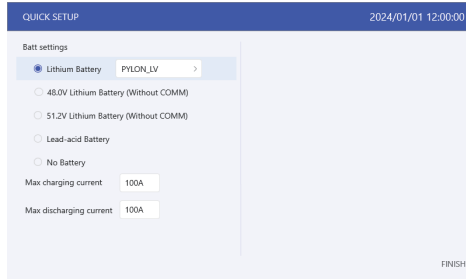

## 5.4.2 HMI screen operation system overview

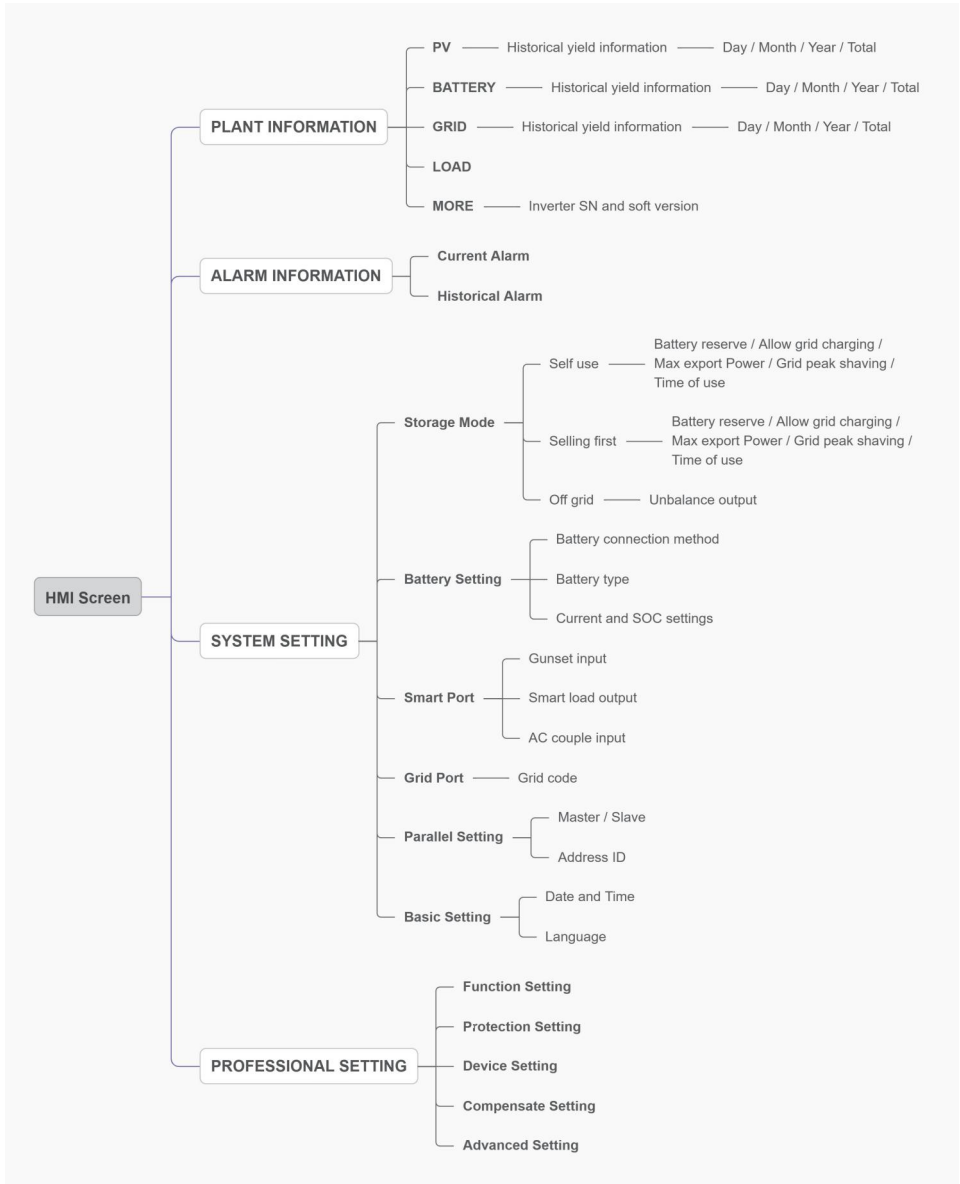

## 5.4.3 Detailed System Setting

### Step 1: Enter Home page

After quick setting, press “ENTER”, the screen displays the home page.

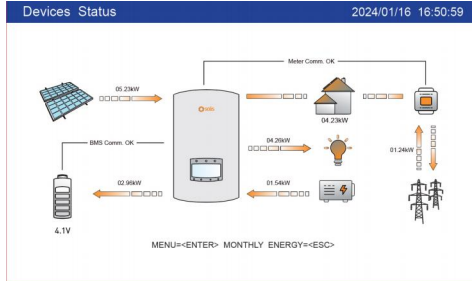

### Step 2: Enter “SYSTEM SETTING” interface

Press “Down”, then press “ENTER” into the “SYSTEM SETTING” interface.



### Step 3: Set “Storage Mode”

Use “UP” or “DOWN” key to select the desired mode, then press “ENTER”.

The Mode description please refer to 5.4.1.

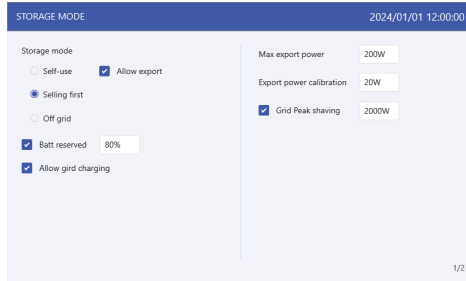

Settings	Description
Battery reserve	Range: 5~95%, default: 80%, settable. When battery SOC < set battery reserve SOC, battery will stop discharging.
Allow grid charging	Allow grid charging the battery when it enables.  Notice: if “Allow Grid Charging” is turned on, the inverter will use grid power to charge the battery only under two circumstances: The battery drains to the Force Charge SOC. When PV power output can’t meet the set current value during the charge periods.
Max export power	Default: 1.1 times of rated power. Notice: if feed-in is not allowed, set Max export power to 0.
Export calibration	Range : -500w-500w, default 20w, settable. To compensate the deviation of CT/Meter in practical application.
Grid peak shaving	Default enable, default 2 times of rated power. Limit the power drawn from the grid to prevent from exceeding regulatory requirements or the power line capacity. When the grid supplies power to the load while charging the battery, it will limit the power used to charge the battery, so that the total power does not exceed the set value. If the grid only supplies power to the load and does not charging the battery, it will be not limited by the setting value.

Table 3 Description of storage mode settings



**NOTE:**

Solis's export power control function is based on the sampling results from the smart meter or smart CT. Due to the sampling interval limitation, when the system's load consumption has sudden changes, small amount of export overshooting is expected. For strict zero injection applications, it is suggested to install external backflow trip device as additional protection for injection.

**Step 4: Set "Time of use" under each mode (Skip this step if no need)**

Time of Use is for manual control of the battery charging/discharging. When the time is between Start and Stop, the system will charge/discharge the battery according to the set Current until the set "SOC/voltage" is reached.

1. Charge period: battery charges with set current value until the charging cut-off voltage (settable), selecting the box to control whether enable this charging period.
2. Discharge period: battery discharges with set current value until the discharging cut-off voltage (settable), selecting the box to control whether enable this discharging period.

STORAGE MODE					2024/01/01 12:00:00				
Charge period					Discharge period				
	Start	Stop	Current	SOC		Start	Stop	Current	SOC
<input checked="" type="checkbox"/>	01 : 00	- 05 : 00	100A	50%	<input checked="" type="checkbox"/>	01 : 00	- 05 : 00	100A	50%
<input type="checkbox"/>	01 : 00	- 05 : 00	100A	50%	<input type="checkbox"/>	01 : 00	- 05 : 00	100A	50%
<input checked="" type="checkbox"/>	01 : 00	- 05 : 00	100A	50%	<input checked="" type="checkbox"/>	01 : 00	- 05 : 00	100A	50%
<input type="checkbox"/>	01 : 00	- 05 : 00	100A	50%	<input type="checkbox"/>	01 : 00	- 05 : 00	100A	50%
<input checked="" type="checkbox"/>	01 : 00	- 05 : 00	100A	50%	<input checked="" type="checkbox"/>	01 : 00	- 05 : 00	100A	50%
<input type="checkbox"/>	01 : 00	- 05 : 00	100A	50%	<input type="checkbox"/>	01 : 00	- 05 : 00	100A	50%



**NOTE:**

The set current value is the maximum current for charging/discharging the battery. However, the actual charging and discharging current may not reach this value due to the influence of other factors, such as the maximum charging/ discharging power limitation of the inverter, the battery BMS limitation, etc.

## Step 5: Set “Battery Setting”

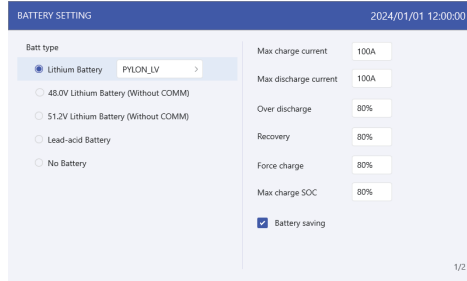

Settings	Description
Max charge current	Max charge current, settable.
Max discharge current	Max discharge current, settable.
Over discharge	Range: 5~40%, default 20%, when battery SOC < over discharge, it will stop discharging.
Recovery	Range: set Over discharge value + 1% ~ set Over discharge value + 20%; The battery can discharge when the SOC/Voltage reaches the set value. Avoid repeated changes in the charging and discharging status of the battery.
Force charge	The battery will be charged to the over discharge SOC/Voltage when it reaches this setting.
Max charge SOC	The maximum SOC/Voltage that the battery can be charged to. Default 100%.

Table 4 Description of battery mode settings



**NOTICE:**

Force charge SOC < Over discharge SOC < Recovery SOC, otherwise the setting might be error.



**NOTE:**

For lead-acid or non-communicated lithium batteries, Solis hybrid inverters are using measured battery voltage to estimate the battery's state of charge (SOC). Due to measurement accuracy and different batteries' behaviours, Solis's estimated battery SOC parameter is for reference only. Solis does NOT guarantee the accuracy for this parameter.

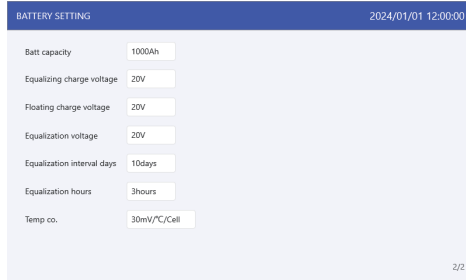

Settings	Description
Batt capacity	The value depends on the actual battery capacity.
Equalizing charge voltage	The three stages of battery charging: Constant Current Charging -- Constant Voltage Charging -- Float Charging You do not need to set this parameter.
Floating charge voltage	
Equalization voltage	Charge the battery to <b>Equalization voltage</b> during the <b>Equalization hours</b> . Ensure that each battery cell is charged to the battery equalization state. After each <b>Equalized Interval days</b> , equalization charging will be performed again.
Equalization interval days	
Equalization hours	
Temp co.	Temperature compensation coefficient. You do not need to set this parameter.

### Step 6: Set “Grid Port”

(Skip this step if grid code is already set in quick setting)

Select grid code that meet the local regulations.

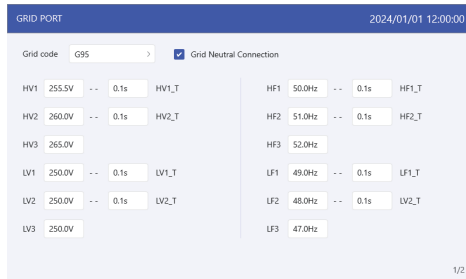

## Step 7: Set “Smart Port”

(Skip this step if the system is not connected to generators)

When it is connected to Generator, select “Gunset input”;

When it is connected to smart load, select “Smart load output”

When it is connected to Grid-tied inverter, select “AC coupled”

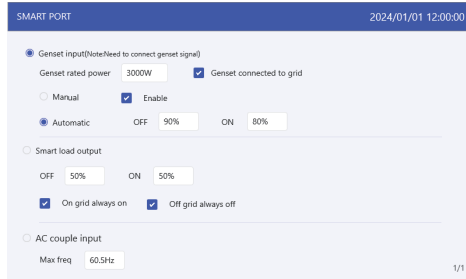

Settings	Description
Genset input	The generator is connected to the GEN port.
Genset connected to grid	The generator is connected to the Grid port.
Manual/Enable	If you want to manually control the start and stop of the generator, you need to select manual. When you need to start the generator, please select Enable.
Automatic OFF/ON	If Automatic is selected, the generator will start when the battery SOC drops to the ON value, and stop when the SOC value reaches the OFF value.
Smart load output OFF/ON	The load is connected to the GEN port as smart load. When the battery SOC/Volt drops to the OFF SOC/Volt, the system will cut off the power of smart load to ensure sufficient power for Backup load. When the battery SOC/Volt reaches the ON SOC/Volt, the smart port will supply power to smart load.
On grid always on	On grid always on: smart port will always supply power to smart load when the grid is available.
Off grid always off	Off grid always off: smart port will cut off power supply to smart load when the grid is off.
AC couple input	The external grid-tied inverter is connected to the GEN port. The hybrid uses Freq-Watt to modulate the output of the PV inverter. Please consult with the PV inverter’s manufacturer to confirm the correct setting procedures of its Freq-Watt response first.

## Step 8: Set parallel system



Settings	Description
Parallel system	When the system is parallel, it needs to be selected.
Master-slave setting	The first inverter must be set as the Master.
ID	The first inverter address is set to 1, the second to 2, and so on. The address of the master must be 1. (Note: The address cannot be set to 0)
Single-phase system/ Three-phase system	Multiple parallel modes are provided, including Single-phase parallel system and three-phase system forming.
L1phase/ L2phase/ L3phase/	If it is three-phase parallel system, please select which phase the inverter is connected to.

## 5.5 APP Setting

### 5.5.1 Log in the APP via Bluetooth

#### Step 1: Connect with Bluetooth.

Turn on Bluetooth switch on your mobile phone and then open the Soliscloud APP.

Click "More Tools"->"Local Operation"->"Connect with Bluetooth"

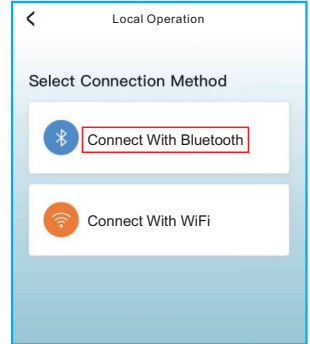
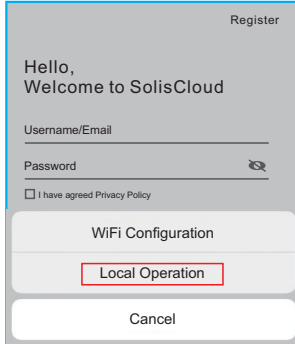
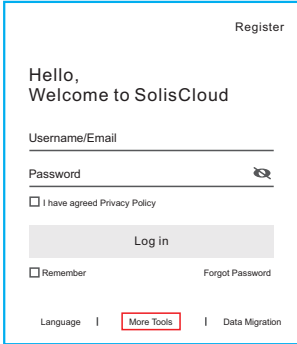

#### Step 2: Select the Bluetooth signal from the inverter. (Bluetooth Name: Inverter SN)

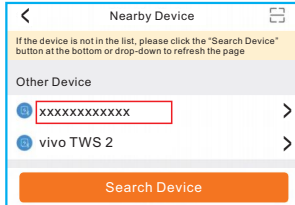

#### Step 3: Login account.

If you are the installer, please select the account type as Installer. If you are the plant owner, please select the account type as owner. Then set your own initial password for control verification. (The first log-in must be finished by installer in order to do the initial set up)

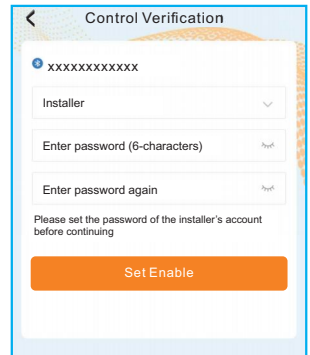
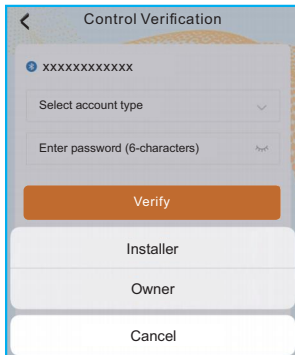
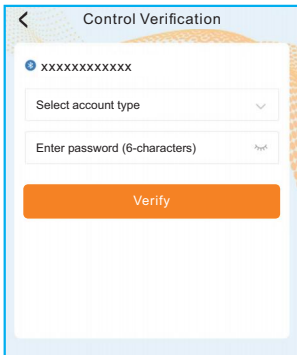

## 5.5.2 APP Quick Setting

If this is the first time the inverter has been commissioned, you will need to first go through the Quick Settings. Once this has been done, these settings can be changed later.

**Inverter Time -> Battery Model -> Meter Setting -> Grid Code -> Work mode**

A. Inverter Time: Set the Inverter Time and Date. It may be easier to tap the slider next to "Follow Phone Time". Then tap Next in the top right corner. This will set the inverter to match your phone.

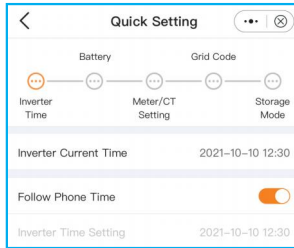

B. If the connected communication lithium battery is on the battery matching list but not found in the model list, you need to select Lithium Battery LV. Set Max charging/discharging current.

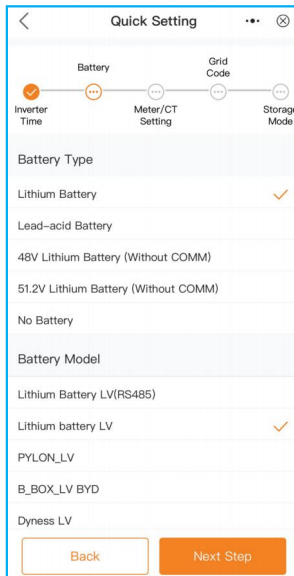

C. Select the CT or Meter, Solis provide ESCT-TA16-100A/50mA CT as standard, and customers can select the meter as an option. If there is no meter connected for the moment, please select "No Meter" to avoid alarms.

Location: Default Grid side.

Direction: Default Forward. The CT installation direction is towards the grid.

CT ratio: Default 2000:1. If the system connected to Meter, then CT ratio need to be set on Meter.

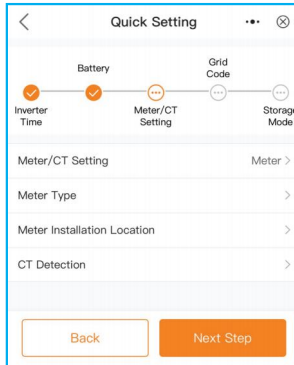

D. Select grid code that meet the local regulations.

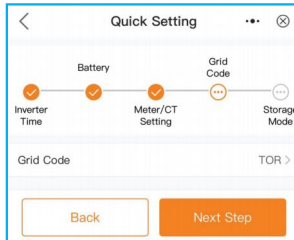

E. All modes first priority is to use the available PV power to power loads. The different modes determine the second priority, which is whether to use excess PV power to charge the battery or feed the grid.

Self-use/Selling first/off grid are exclusive, and users can only select one mode.

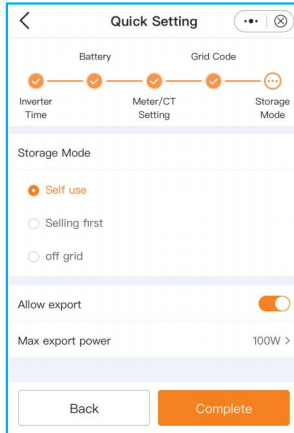

Solis S6 Series inverter does not require any regular maintenance. However, cleaning the heatsink will help the inverter dissipate heat and increase the lifetime of inverter. The dirt on the inverter can be cleaned with a soft brush.



**CAUTION:**

Do not touch the surface when the inverter is operating. Some parts may be hot and could cause burns. Turn OFF the inverter and let it cool down before you do any maintenance or cleaning of inverter.

The Screen and the LED status indicator lights can be cleaned with cloth if they are too dirty to be read.



**NOTE:**

Never use any solvents, abrasives, or corrosive materials to clean the inverter.

## 6.1 Smart O&M

In order to improve our products and provide you with higher quality services, this device has a built-in data logging module for collecting relevant information during operation (such as power generation data, fault data)

**Commitment:**

1. We will only collect, use and process your device information for the purpose of improving our products and services.
2. We will take all reasonable and feasible measures to ensure that no irrelevant information is collected and we will protect your device information.
3. We will not share, transfer or disclose the collected device information with any company, organization or individual.
4. When we stop operating products or services, we will stop collecting your device information in a timely manner.
5. If you do not want to provide such information, you can notify our company to turn off this function, which will not affect your normal use of other functions of the product.

Message Name	Information Description	Troubleshooting Suggestion
Off	Control device to shutdown	1. Turn on the device in the ON/OFF Setting.
LmtByEPM	The device's output is under controlled	<ol style="list-style-type: none"> <li>1. Confirm whether the inverter is connected to an external EPM/meter to prevent reverse current.</li> <li>2. Confirm whether the inverter is controlled by an external third-party device.</li> <li>3. Confirm whether the power setting of the inverter power control is limited.</li> <li>4. Verify settings in section 6.6.7 and check your meter readings.</li> </ol>
LmtByDRM	DRM Function ON	1. No need to deal with it.
LmtByTemp	Over temperature power limited	1. No need to deal with it, the device is in normal operation.
LmtByFreq	Frequency power limited	
LmtByVg	The device is in the Volt-Watt mode	<ol style="list-style-type: none"> <li>1. Due to the requirements of local safety regulations, when the grid voltage is high, the Volt-watt working mode is triggered, which generally does not need to be dealt with.</li> <li>2. Inverter factory test errors causing this mode to open, if you need to close, you can close this mode in LCD, set the process: Main menu → Advanced Settings → Password 0010 → STD mode settings → Working Mode → Working mode: NULL → Save and exit.</li> </ol>
LmtByVar	The device is in the Volt-Var mode of operation	<ol style="list-style-type: none"> <li>1. Due to the requirements of local safety regulations, when the grid voltage is high, the Volt-watt working mode is triggered, which generally does not need to be dealt with.</li> <li>2. Inverter factory test errors causing this mode to open, if you need to close, you can close this mode in LCD, set the process: Main menu → Advanced Settings → Password 0010 → STD mode settings → Working Mode → Working mode: NULL → Save and exit.</li> </ol>
LmtByUnFr	Under frequency limit	1. No need to deal with it.
Standby	Bypass run	
StandbySynoch	Off grid status to On grid status	
GridToLoad	Grid to load	

# 7. Troubleshooting

Message Name	Information Description	Troubleshooting Suggestion
Surge Alarm	On-site grid surge	1. Grid side fault, restart the device. If it is still not eliminated, please contact the manufacturer's customer service.
OV-G-V01	Grid voltage exceeds the upper voltage range	1. Confirm whether the power grid is abnormal. 2. Confirm that the AC cable is properly connected. 3. Restart the system and check if the fault persists.
UN-G-V01	Grid voltage exceeds the lower voltage range	
OV-G-F01	Grid frequency exceeds the upper frequency range	
UN-G-F01	Grid frequency exceeds the lower frequency range	
G-PHASE	Unbalanced grid voltage	
G-F-GLU	Grid voltage frequency fluctuation	
NO-Grid	No grid	
OV-G-V02	Grid transient overvoltage	
OV-G-V03	Grid transient overvoltage	1. Restart the system, confirm if that the fault continues.
IGFOL-F	Grid current tracking failure	1. Confirm whether the power grid is abnormal. 2. Confirm that the AC cable is properly connected. 3. Restart the system and check if the fault persists.
OV-G-V05	Grid voltage RMS instantaneous overvoltage fault	
OV-G-V04	Grid voltage exceeds the upper voltage range	
UN-G-V02	Grid voltage exceeds the lower voltage range	
OV-G-F02	Grid frequency exceeds the upper frequency range	
UN-G-F02	Grid frequency exceeds the lower frequency range	
NO-Battery	Battery is not connected	1. Check on information page 1 – Verify the battery voltage is within standards. 2. Measure battery voltage at plug.
OV-Vbackup	Inverting overvoltage	1. Check whether the backup port wiring is normal 2. Restart the system, confirm that the fault continues.
Over-Load	Load overload fault	1. Backup load power is too large, or some inductive load startup power is too large, need to remove some backup load, or remove the inductive load on the backup.

# 7. Troubleshooting

Message Name	Information Description	Troubleshooting Suggestion
BatName-FAIL	Wrong battery brand selection	1. Confirm whether the battery model selection is consistent with the actual one.
CAN Fail	CAN Fail	1. Can failure is a failure of communication between inverter and battery. Check cable conditions. Check to ensure you have it plugged in on the CAN port of the battery and inverter. Check that you are using the right cable. Some batteries require a special battery from the battery manufacturer.
OV-Vbatt	Battery overvoltage detected	1. Verify battery voltage is within standards. Measure battery voltage at inverter connection point. Contact your battery manufacturer for further service.
UN-Vbatt	Battery undervoltage detected	1. Restart the system and check if the fault persists. If it is still not eliminated, please contact the manufacturer's customer service.
Fan Alarm	Fan alarm	1. Check if the internal fan is working correctly or jammed.
OV-DC01 (1020 DATA:0001)	DC 1 input overvoltage	1. Check if the PV voltage is abnormal 2. Restart the system, confirm that the fault continues
OV-DC02 (1020 DATA:0002)	DC 2 input overvoltage	
OV-BUS (1021 DATA:0000)	DC bus overvoltage	1. Restart the system, confirm that the fault continues.
UN-BUS01 (1023 DATA:0001)	DC bus undervoltage	
UNB-BUS (1022 DATA:0000)	DC bus unbalanced voltage	
UN-BUS02 (1023 DATA:0002)	Abnormal detection of DC bus voltage	
DC-INTF. (1027 DATA:0000)	DC hardware overcurrent (1, 2, 3, 4)	1. Check if the DC wires are connected correctly without loose connection.
OV-G-I (1018 DATA:0000)	Aphase RMS value overcurrent	1. Confirm that the grid is abnormal. 2. Confirm that the AC cable connection is not abnormal. 3. Restart the system, confirm that the fault continues.
OV-DCA-I (1025 DATA:0000)	DC 1 average overcurrent	1. Restart the system, confirm that the fault continues.
OV-DCB-I (1026 DATA:0000)	DC 2 average overcurrent	
GRID-INTF. (1030 DATA:0000)	AC hardware overcurrent (abc phase)	

Message Name	Information Description	Troubleshooting Suggestion
DCInj-FAULT (1037 DATA:0000)	The current DC component exceeds the limit	<ol style="list-style-type: none"> <li>1. Confirm that the grid is abnormal.</li> <li>2. Confirm that the AC cable connection is not abnormal.</li> <li>3. Restart the system, confirm that the fault continues.</li> </ol>
IGBT-OV-I (1048 DATA:0000)	IGBT overcurrent	<ol style="list-style-type: none"> <li>1. Restart the system, confirm that the fault continues.</li> </ol>
OV-TEM (1032 DATA:0000)	Module over temperature	<ol style="list-style-type: none"> <li>1. Check whether the surrounding environment of the inverter has poor heat dissipation.</li> <li>2. Confirm whether the product installation meets the requirements.</li> </ol>
RelayChk-FAIL (1035 DATA:0000)	Relay failure	<ol style="list-style-type: none"> <li>1. Restart the system, confirm that the fault continues.</li> </ol>
UN-TEM (103A DATA:0000)	Low temperature protection	<ol style="list-style-type: none"> <li>1. Check the working environment temperature of the inverter.</li> <li>2. Restart the system to confirm if the fault continues.</li> </ol>
PV ISO-PRO01 (1033 DATA:0001)	PV negative ground fault	<ol style="list-style-type: none"> <li>1. Check whether the PV strings have insulation problems.</li> <li>2. Check whether the PV cable is damaged.</li> </ol>
PV ISO-PRO02 (1033 DATA:0002)	PV positive ground fault	
12Power-FAULT (1038 DATA:0000)	12V undervoltage failure	<ol style="list-style-type: none"> <li>1. Check current leakage to ground. Verify your grounding. Verify all wires are in good condition and not leaking current to ground.</li> </ol>
ILeak-PRO01 (1034 DATA:0001)	Leakage current failure 01 (30mA)	
ILeak-PRO02 (1034 DATA:0002)	Leakage current failure 02 (60mA)	
ILeak-PRO03 (1034 DATA:0003)	Leakage current failure 03 (150mA)	
ILeak-PRO04 (1034 DATA:0004)	Leakage current failure 04	
ILeak_Check (1039 DATA:0000)	Leakage current sensor failure	
GRID-INTF02 (1046 DATA:0000)	Power grid disturbance 02	<ol style="list-style-type: none"> <li>1. Confirm whether the grid is seriously distorted.</li> <li>2. Check whether the AC cable is connected reliably.</li> </ol>
OV-Vbatt-H/ OV-BUS-H (1051 DATA:0000)	Battery overvoltage hardware failure / VBUS	<ol style="list-style-type: none"> <li>1. Check if the battery circuit breaker is tripping.</li> <li>2. Check if the battery is damaged.</li> </ol>

Message Name	Information Description	Troubleshooting Suggestion
OV-ILLC (1052 DATA:0000)	LLC hardware overcurrent	1. Check whether the backup load is overloaded. 2. Restart the system, confirm that the fault continues.
INI-FAULT (1031 DATA:0000)	AD zero drift overlink	1. Restart the system, confirm that the fault continues.
DSP-B-FAULT (1036 DATA:0000)	The master-slave DSP communication is abnormal	
AFCI-Check (1040 DATA:0000)	AFCI self-test failure	
ARC- FAULT (1041 DATA:0000)	AFCI failure	1. Verify connections are tight within your PV system. Arc fault settings can be changed in advanced settings if further adjustment is necessary.

Table 7.1 Fault message and description



**NOTE:**

If the inverter displays any alarm message as listed in Table 8.1; please turn off the inverter and wait for 5 minutes before restarting it .  
If the failure persists, please contact your local distributor or the service center.

Please keep ready with you the following information before contacting us.

1. Serial number of Solis Singles Phase Inverter;
2. The distributor/dealer of Solis Singles Phase Inverter (if available);
3. Installation date.
4. The description of the problem together with necessary information, pictures, attachment.
5. The PV array configuration (e.g. number of panels, capacity of panels, number of strings, etc.);
6. Your contact details.

# 8. Specifications

Technical Data	S6-EH1P9.9K03-NV-YD-L
<b>Input DC (PV side)</b>	
Recommended max. PV power	19800W
Max Usable PV Input Power	15840W
Max. input voltage	550V
Rated voltage	380V
Start-up voltage	100V
MPPT voltage range	100-450V
Full load MPPT voltage range	166-450V
Max. input power per MPPT	12kW
Max. input current	40A/40A/40A
Max. short circuit current	50A/50A/50A
MPPT number/Max input strings number	3/6
<b>Battery</b>	
Battery Type	Lithium-ion/Lead-acid
Battery Voltage range	40 - 60V
Max. charge / discharge power	9.9kW
Max. charge / discharge current	208A
Battery Switch	Yes
Communication	CAN/RS485
<b>Output AC(Grid side)</b>	
Rated output power	9.9kW
Max. apparent output power	9.9kVA
Operation phase	1/N/PE
Rated grid voltage	220 V/230 V
The grid voltage range	187-253 V
AC GRID inrush current/Duration	4.3-4.5A/5ms
Rated grid frequency	50 Hz/60 Hz
AC grid frequency range	45-55 Hz/55-65 Hz
Rated grid output current	45.0 A/43.1 A
Max. output current	45.0 A/43.1 A
Power factor range	-0.8...1...+0.8
THDi	<3%

# 8. Specifications

Technical Data	S6-EH1P9.9K03-NV-YD-L
<b>Input AC (Grid side)</b>	
Input voltage range	187-253V
Max. input current	67.5 A/64.5 A
Frequency range	45-55 Hz/ 55-65Hz
<b>Output AC(Back-up)</b>	
Rated output power	9.9kW
Max. apparent output power	2 times of rated power, 10 S
Back-up switch time	<4ms
Rated output voltage	L/N/PE, 220 V/230 V
Rated frequency	50Hz/60Hz
Rated. output current	45.0 A/43.1 A
Max. output overcurrent protection, 10sec	90.1 A
Max. Continuous AC Passthrough	90 A
THDv(@linear load)	<3%
Maximum number of parallel	6
<b>Input - Generator</b>	
Max. input power	9.9kW
Max. input current	45.0 A/43.1 A
Rated input frequency	50Hz/60Hz
<b>Efficiency</b>	
Max. efficiency	97.6%
EU efficiency	97.0%
<b>Protection</b>	
DC surge protection/AC surge protection	Yes
Ground fault detection	Yes
Residual current monitoring unit	Yes
Integrated AFCI (DC arc-fault circuit protection)	Yes
DC reverse-polarity protection	Yes (PV only)
Over voltage category	DC type II/AC type III

# 8. Specifications

Technical Data	S6-EH1P9.9K03-NV-YD-L
<b>General data</b>	
Dimensions(W/H/D)	459*845*313mm
Weight	55.5kg
Topology	Transformerless
Operation temperature range	-25°C ~ +60°C
Ingress protection	TYPE 4X(IP66)
Cooling concept	Smart Fan cooling
Max.operation altitude	4000m
Grid connection standard	NRS 097-2-1, IEC 62116, IEC 61727, IEC 60068, IEC 61683, EN 50530,EN50549-1
Safty/EMC standard	IEC/EN 62109-1/-2, EN 61000-6-2/-3
<b>Features</b>	
DC connection	MC4 plug(PV port)/Terminal Block(BAT port)
AC connection	Terminal Block
Display	LED+Bluetooth+APP
Communication	RS485,CAN, Optional: Cellular, Wi-Fi, LAN
Warranty	5 years standard (extend to 20 years)

# 8. Specifications

Technical Data	S6-EH1P10K03-NV-YD-L
<b>Input DC (PV side)</b>	
Recommended max. PV power	20000W
Max Usable PV Input Power	16000W
Max. input voltage	550V
Rated voltage	380V
Start-up voltage	100V
MPPT voltage range	100-450V
Full load MPPT voltage range	166-450V
Max. input power per MPPT	12kW
Max. input current	40A/40A/40A
Max. short circuit current	50A/50A/50A
MPPT number/Max input strings number	3/6
<b>Battery</b>	
Battery Type	Lithium-ion/Lead-acid
Battery Voltage range	40 - 60V
Max. charge / discharge power	10kW
Max. charge / discharge current	208A
Battery Switch	Yes
Communication	CAN/RS485
<b>Output AC(Grid side)</b>	
Rated output power	10kW
Max. apparent output power	10kVA
Operation phase	1/N/PE
Rated grid voltage	220 V/230 V
The grid voltage range	187-253 V
AC GRID inrush current/Duration	4.4-4.6A/5ms
Rated grid frequency	50 Hz/60 Hz
AC grid frequency range	45-55 Hz/55-65 Hz
Rated grid output current	45.5 A/43.5 A
Max. output current	45.5 A/43.5 A
Power factor range	-0.8...1...+0.8
THDi	<3%

# 8. Specifications

Technical Data	S6-EH1P10K03-NV-YD-L
<b>Input AC (Grid side)</b>	
Input voltage range	187-253V
Max. input current	68.2 A/65.2 A
Frequency range	45-55 Hz/ 55-65Hz
<b>Output AC(Back-up)</b>	
Rated output power	10kW
Max. apparent output power	2 times of rated power, 10 S
Back-up switch time	<4ms
Rated output voltage	L/N/PE, 220 V/230 V
Rated frequency	50Hz/60Hz
Rated. output current	45.5 A/43.5 A
Max. output overcurrent protection, 10sec	91 A
Max. Continuous AC Passthrough	90 A
THDv(@linear load)	<3%
Maximum number of parallel	6
<b>Input - Generator</b>	
Max. input power	10kW
Max. input current	45.5 A/43.5 A
Rated input frequency	50Hz/60Hz
<b>Efficiency</b>	
Max. efficiency	97.6%
EU efficiency	97.0%
<b>Protection</b>	
DC surge protection/AC surge protection	Yes
Ground fault detection	Yes
Residual current monitoring unit	Yes
Integrated AFCI (DC arc-fault circuit protection)	Yes
DC reverse-polarity protection	Yes (PV only)
Over voltage category	DC type II/AC type III

# 8. Specifications

Technical Data	S6-EH1P10K03-NV-YD-L
<b>General data</b>	
Dimensions(W/H/D)	459*845*313mm
Weight	55.5kg
Topology	Transformerless
Operation temperature range	-25°C ~ +60°C
Ingress protection	TYPE 4X(IP66)
Cooling concept	Smart Fan cooling
Max.operation altitude	4000m
Grid connection standard	NRS 097-2-1, IEC 62116, IEC 61727, IEC 60068, IEC 61683, EN 50530,EN50549-1
Safty/EMC standard	IEC/EN 62109-1/-2, EN 61000-6-2/-3
<b>Features</b>	
DC connection	MC4 plug(PV port)/Terminal Block(BAT port)
AC connection	Terminal Block
Display	LED+Bluetooth+APP
Communication	RS485,CAN, Optional: Cellular, Wi-Fi, LAN
Warranty	5 years standard (extend to 20 years)

# 8. Specifications

Technical Data	S6-EH1P12K03-NV-YD-L
<b>Input DC (PV side)</b>	
Recommended max. PV power	24000W
Max Usable PV Input Power	19200W
Max. input voltage	550V
Rated voltage	380V
Start-up voltage	100V
MPPT voltage range	100-450V
Full load MPPT voltage range	166-450V
Max. input power per MPPT	12kW
Max. input current	40A/40A/40A
Max. short circuit current	50A/50A/50A
MPPT number/Max input strings number	3/6
<b>Battery</b>	
Battery Type	Lithium-ion/Lead-acid
Battery Voltage range	40 - 60V
Max. charge / discharge power	12kW
Max. charge / discharge current	250A
Battery Switch	Yes
Communication	CAN/RS485
<b>Output AC(Grid side)</b>	
Rated output power	12kW
Max. apparent output power	12kVA
Operation phase	1/N/PE
Rated grid voltage	220 V/230 V
The grid voltage range	187-253 V
AC GRID inrush current/Duration	5.2-5.5A/5ms
Rated grid frequency	50 Hz/60 Hz
AC grid frequency range	45-55 Hz/55-65 Hz
Rated grid output current	54.5 A/52.2 A
Max. output current	54.5 A/52.2 A
Power factor range	-0.8...1...+0.8
THDi	<3%

# 8. Specifications

Technical Data	S6-EH1P12K03-NV-YD-L
<b>Input AC (Grid side)</b>	
Input voltage range	187-253V
Max. input current	81.8 A/78.3 A
Frequency range	45-55 Hz/ 55-65Hz
<b>Output AC(Back-up)</b>	
Rated output power	12kW
Max. apparent output power	2 times of rated power, 10 S
Back-up switch time	<4ms
Rated output voltage	L/N/PE, 220 V/230 V
Rated frequency	50Hz/60Hz
Rated. output current	54.5 A/52.2 A
Max. output overcurrent protection, 10sec	109 A
Max. Continuous AC Passthrough	90 A
THDv(@linear load)	<3%
Maximum number of parallel	6
<b>Input - Generator</b>	
Max. input power	12kW
Max. input current	54.5 A/52.2 A
Rated input frequency	50Hz/60Hz
<b>Efficiency</b>	
Max. efficiency	97.6%
EU efficiency	97.0%
<b>Protection</b>	
DC surge protection/AC surge protection	Yes
Ground fault detection	Yes
Residual current monitoring unit	Yes
Integrated AFCI (DC arc-fault circuit protection)	Yes
DC reverse-polarity protection	Yes (PV only)
Over voltage category	DC type II/AC type III

# 8. Specifications

Technical Data	S6-EH1P12K03-NV-YD-L
<b>General data</b>	
Dimensions(W/H/D)	459*845*313mm
Weight	55.5kg
Topology	Transformerless
Operation temperature range	-25°C ~ +60°C
Ingress protection	TYPE 4X(IP66)
Cooling concept	Smart Fan cooling
Max.operation altitude	4000m
Grid connection standard	NRS 097-2-1, IEC 62116, IEC 61727, IEC 60068, IEC 61683, EN 50530,EN50549-1
Safty/EMC standard	IEC/EN 62109-1/-2, EN 61000-6-2/-3
<b>Features</b>	
DC connection	MC4 plug(PV port)/Terminal Block(BAT port)
AC connection	Terminal Block
Display	LED+Bluetooth+APP
Communication	RS485,CAN, Optional: Cellular, Wi-Fi, LAN
Warranty	5 years standard (extend to 20 years)

# 8. Specifications

Technical Data	S6-EH1P14K03-NV-YD-L
<b>Input DC (PV side)</b>	
Recommended max. PV power	28000W
Max Usable PV Input Power	22400W
Max. input voltage	550V
Rated voltage	380V
Start-up voltage	100V
MPPT voltage range	100-450V
Full load MPPT voltage range	186-450V
Max. input power per MPPT	12kW
Max. input current	40A/40A/40A
Max. short circuit current	50A/50A/50A
MPPT number/Max input strings number	3/6
<b>Battery</b>	
Battery Type	Lithium-ion/Lead-acid
Battery Voltage range	40 - 60V
Max. charge / discharge power	14kW
Max. charge / discharge current	290A
Battery Switch	Yes
Communication	CAN/RS485
<b>Output AC(Grid side)</b>	
Rated output power	14kW
Max. apparent output power	14kVA
Operation phase	1/N/PE
Rated grid voltage	220 V/230 V
The grid voltage range	187-253 V
AC GRID inrush current/Duration	6.1-6.4A/5ms
Rated grid frequency	50 Hz/60 Hz
AC grid frequency range	45-55 Hz/55-65 Hz
Rated grid output current	63.6 A/60.9 A
Max. output current	63.6 A/60.9 A
Power factor range	-0.8...1...+0.8
THDi	<3%

# 8. Specifications

Technical Data	S6-EH1P14K03-NV-YD-L
<b>Input AC (Grid side)</b>	
Input voltage range	187-253V
Max. input current	95.5 A/91.3 A
Frequency range	45-55 Hz/ 55-65Hz
<b>Output AC(Back-up)</b>	
Rated output power	14kW
Max. apparent output power	2 times of rated power, 10 S
Back-up switch time	<4ms
Rated output voltage	L/N/PE, 220 V/230 V
Rated frequency	50Hz/60Hz
Rated. output current	63.6 A/60.9 A
Max. output overcurrent protection, 10sec	127 A
Max. Continuous AC Passthrough	90 A
THDv(@linear load)	<3%
Maximum number of parallel	6
<b>Input - Generator</b>	
Max. input power	14kW
Max. input current	63.6 A/60.9 A
Rated input frequency	50Hz/60Hz
<b>Efficiency</b>	
Max. efficiency	97.6%
EU efficiency	97.0%
<b>Protection</b>	
DC surge protection/AC surge protection	Yes
Ground fault detection	Yes
Residual current monitoring unit	Yes
Integrated AFCI (DC arc-fault circuit protection)	Yes
DC reverse-polarity protection	Yes (PV only)
Over voltage category	DC type II/AC type III

# 8. Specifications

Technical Data	S6-EH1P14K03-NV-YD-L
<b>General data</b>	
Dimensions(W/H/D)	459*845*313mm
Weight	55.5kg
Topology	Transformerless
Operation temperature range	-25°C ~ +60°C
Ingress protection	TYPE 4X(IP66)
Cooling concept	Smart Fan cooling
Max.operation altitude	4000m
Grid connection standard	NRS 097-2-1, IEC 62116, IEC 61727, IEC 60068, IEC 61683, EN 50530,EN50549-1
Safty/EMC standard	IEC/EN 62109-1/-2, EN 61000-6-2/-3
<b>Features</b>	
DC connection	MC4 plug(PV port)/Terminal Block(BAT port)
AC connection	Terminal Block
Display	LED+Bluetooth+APP
Communication	RS485,CAN, Optional: Cellular, Wi-Fi, LAN
Warranty	5 years standard (extend to 20 years)

# 8. Specifications

Technical Data	S6-EH1P16K03-NV-YD-L
<b>Input DC (PV side)</b>	
Recommended max. PV power	32000W
Max Usable PV Input Power	22400W
Max. input voltage	550V
Rated voltage	380V
Start-up voltage	100V
MPPT voltage range	100-450V
Full load MPPT voltage range	186-450V
Max. input power per MPPT	12kW
Max. input current	40A/40A/40A
Max. short circuit current	50A/50A/50A
MPPT number/Max input strings number	3/6
<b>Battery</b>	
Battery Type	Lithium-ion/Lead-acid
Battery Voltage range	40 - 60V
Max. charge / discharge power	16kW
Max. charge / discharge current	290A
Battery Switch	Yes
Communication	CAN/RS485
<b>Output AC(Grid side)</b>	
Rated output power	16kW
Max. apparent output power	16kVA
Operation phase	1/N/PE
Rated grid voltage	220 V/230 V
The grid voltage range	187-253 V
AC GRID inrush current/Duration	7.0-7.3A/5ms
Rated grid frequency	50 Hz/60 Hz
AC grid frequency range	45-55 Hz/55-65 Hz
Rated grid output current	72.7 A/69.6 A
Max. output current	72.7 A/69.6 A
Power factor range	-0.8...1...+0.8
THDi	<3%

# 8. Specifications

Technical Data	S6-EH1P16K03-NV-YD-L
<b>Input AC (Grid side)</b>	
Input voltage range	187-253V
Max. input current	109.1 A/104.3 A
Frequency range	45-55 Hz/ 55-65Hz
<b>Output AC(Back-up)</b>	
Rated output power	16kW
Max. apparent output power	2 times of rated power, 10 S
Back-up switch time	<4ms
Rated output voltage	L/N/PE, 220 V/230 V
Rated frequency	50Hz/60Hz
Rated. output current	72.7 A/69.6 A
Max. output overcurrent protection, 10sec	145 A
Max. Continuous AC Passthrough	90 A
THDv(@linear load)	<3%
Maximum number of parallel	6
<b>Input - Generator</b>	
Max. input power	16kW
Max. input current	72.7 A/69.6 A
Rated input frequency	50Hz/60Hz
<b>Efficiency</b>	
Max. efficiency	97.6%
EU efficiency	97.0%
<b>Protection</b>	
DC surge protection/AC surge protection	Yes
Ground fault detection	Yes
Residual current monitoring unit	Yes
Integrated AFCI (DC arc-fault circuit protection)	Yes
DC reverse-polarity protection	Yes (PV only)
Over voltage category	DC type II/AC type III

# 8. Specifications

Technical Data	S6-EH1P16K03-NV-YD-L
<b>General data</b>	
Dimensions(W/H/D)	459*845*313mm
Weight	55.5kg
Topology	Transformerless
Operation temperature range	-25°C ~ +60°C
Ingress protection	TYPE 4X(IP66)
Cooling concept	Smart Fan cooling
Max.operation altitude	4000m
Grid connection standard	NRS 097-2-1, IEC 62116, IEC 61727, IEC 60068, IEC 61683, EN 50530,EN50549-1
Safty/EMC standard	IEC/EN 62109-1/-2, EN 61000-6-2/-3
<b>Features</b>	
DC connection	MC4 plug(PV port)/Terminal Block(BAT port)
AC connection	Terminal Block
Display	LED+Bluetooth+APP
Communication	RS485,CAN, Optional: Cellular, Wi-Fi, LAN
Warranty	5 years standard (extend to 20 years)

## Frequently Asked Questions

### **Q1: Why I have "CAN Fail" Alarm on the inverter?**

A: "CAN Fail" indicates the CAN communication between inverter and battery is lost. Please double check if your CAN cable is correctly connected and if your battery is power on.

### **Q2: Why I have "BATName-Fail" Alarm on the inverter ?**

A: Please check in the "Battery Setting->Battery Model" setting and confirm you selected the correct battery option as the nameplate of your battery module.

### **Q3: Why I have "MET-SLT-Fail" Alarm on the inverter?**

A: Please check in the "Meter Setting->Meter Type" setting and confirm you selected the correct meter option corresponding to your smart meter.

### **Q4: Why the power values on the screen are fluctuating very fast?**

A: If your loads are changing drastically, the inverter will adjust its power accordingly. If you confirm the loads are stable while the inverter power is changing very fast, please double check your meter CT's direction and make sure the arrow is towards grid.

### **Q5: Why I have "OV-ILLC" Alarm on the inverter ?**

A: OV-ILLC indicates there is an overcurrent issue on the internal LLC circuit. It could be transient status during extreme condition such as overload. If it happens constantly or too frequent and the extreme conditions have been excluded, please contact Solis service team.

### **Q6: Why I have "OV-BATT-H" Alarm on the inverter ?**

A: OV-BATT-H indicates over voltage issue on the hardware of battery circuit. It could be caused by high battery voltage at full SOC, battery suddenly switching off, etc. If it happens constantly or too frequent and the extreme conditions have been excluded, please contact Solis service team.

### **Q7: Why I have "No-Battery" Alarm on the inverter?**

A: Please double check if the battery power cables have been correctly connected and the battery breaker (on battery or external) has been turn on. If you don't want to connect the battery for now, please select the "No battery" option in "Battery Setting->Battery Model" to prevent the alarm to show up.

Ginlong Technologies Co., Ltd.

No. 57 Jintong Road, Binhai Industrial Park, Xiangshan, Ningbo,  
Zhejiang, 315712, P.R.China.

Tel: +86 (0)574 6578 1806

Email: [info@ginlong.com](mailto:info@ginlong.com)

Web: [www.solisinverters.com](http://www.solisinverters.com)

Please adhere to the actual products in case of any discrepancies in this user manual.

If you encounter any problem on the inverter, please find out the inverter S/N and contact us, we will try to respond to your question ASAP.